

# **3-CCD Color Camera MODEL HV-D20P**

## **OPERATION MANUAL**



Please read this operation manual carefully for proper operation, and keep it for future reference.

**Note:** The model and serial numbers of your product are important for you to keep for your convenience and protection. These numbers appear on the nameplate located on the bottom of the product. Please record these numbers in the spaces provided below, and retain this manual for future reference.

**Model No.** \_\_\_\_\_

**Serial No.** \_\_\_\_\_

**Hitachi Kokusai Electric Inc.**

# IMPORTANT SAFETY INSTRUCTIONS

## 1. Read Instructions

All the safety and operating instructions should be read before the product is operated.

## 2. Retain Instructions

The safety and operating instructions should be retained for future reference.

## 3. Heed Warnings

All warnings on the product and the operating instructions should be adhered to.

## 4. Follow Instructions

All operating and use instructions should be followed.

## 5. Cleaning

Unplug this product from the wall outlet before cleaning. Do not use liquid cleaners or aerosol cleaners. Use a damp cloth for cleaning.

## 6. Attachments

Do not use attachments not recommended by the product manufacturer as they may cause hazards.

## 7. Water and Moisture

Do not use this product near water - for example, near a bath tub, wash bowl, kitchen sink, or laundry tub; in a wet basement; or near a swimming pool; and the like.

## 8. Accessories

Do not place this product on an unstable cart, stand, tripod, bracket, or table. The product may fall, causing serious injury to a child or adult, and serious damage to the product. Use only with a cart, stand, tripod, bracket, or table recommended by the manufacturer, or sold with the product. Any mounting of the product should follow the manufacturer's instructions, and should use a mounting accessory recommended by the manufacturer.

## 9. Moving

A product and cart combination should be moved with care.

Quick stops, excessive force, and uneven surfaces may cause the product and cart combination to overturn.

## 10. Ventilation

Slots and openings in the cabinet are provided for ventilation and to ensure reliable operation of the product and to protect it from overheating, and these openings must not be blocked or covered.

The openings should never be blocked by placing the product on a bed, sofa, rug, or other similar surface. This product should not be placed in a

built-in installation such as a bookcase or rack unless proper ventilation is provided or the manufacturer's instructions have been adhered to.

#### **11. Power Sources**

This product should be operated only from the type of power source indicated on the marking label. If you are not sure of the type of power supply to your home, consult your product dealer or local power company. For products intended to operate from battery power, or other sources, refer to the operating instructions.

#### **12. Grounding or Polarization**

This product is equipped with a three-wire grounding-type plug a plug having a third (grounding) pin. This plug will only fit into a grounding-type power outlet. This is a safety feature. If you are unable to insert the plug into the outlet, contact your electrician to replace your obsolete outlet. Do not defeat the safety purpose of the grounding-type plug.

#### **13. Power-Cord Protection**

Power-supply cords should be routed to that they are not likely to be walked on or pinched by items placed upon or against them, paying particular attention to cords at plug, convenience

receptacles, and the point where they exit from the product.

#### **14. Lightning**

For added protection for this product during a lightning storm, or when it is left unattended and unused for long periods of time, unplug it from the wall outlet. This will prevent damage to the product due to lightning and power-line surges.

#### **15. Overloading**

Do not overload wall outlets, extension cords or integral convenience receptacles as this can result in a risk of fire or electric shock.

#### **16. Object and Liquid Entry**

Never push objects of any kind into this product through openings as they may touch dangerous voltage points or short-out parts that could result in a fire or electric shock. Never spill liquid of any kind on the product.

#### **17. Inflammable and Explosive Substance**

Avoid using this product where there are gases, and also where there are inflammable and explosive substances in the immediate vicinity.

#### **18. Heavy Shock or Vibration**

When carrying this product around, do not subject the product to heavy shock or vibration.

## **19. Servicing**

Do not attempt to service this product yourself as opening or removing covers may expose you to dangerous voltage or other hazards. Refer all servicing to qualified service personnel.

## **20. Damage Requiring Service**

Unplug this product from the wall outlet and refer servicing to qualified service personnel under the following conditions:

- a. When the power-supply cord or plug is damaged.
- b. If liquid has been spilled, or objects have fallen into the product.
- c. If the product has been exposed to rain or water.
- d. If the product does not operate normally by following the operating instructions. Adjust only those controls that are covered by the operating instructions as an improper adjustment of other controls may result in damage and will often require extensive work by a qualified technician to restore the product to its normal operation.
- e. If the product has been dropped or damaged in any way.
- f. When the product exhibits a distinct change in

performance-this indicates a need for service.

## **21. Replacement Parts**

When replacement parts are required, be sure the service technician has used replacement parts specified by the manufacturer or have the same characteristics as the original part.

Unauthorized substitutions may result in fire, electric shock, or other hazards.

## **22. Safety Check**

Upon completion of any service or repairs to this product, ask the service technician to perform safety checks to determine that the product is in proper operating condition.

## **23. Wall or Ceiling Mounting**

The product should be mounted to a wall or ceiling only as recommended by the manufacturer.

## **24. Heat**

The product should be situated away from heat sources such as radiators, heat registers, stoves, or other products (including amplifiers) that produce heat.

# WICHTIGE SICHERHEITSANWEISUNGEN

## 1. Alle Anweisungen lesen

Vor Betrieb des Erzeugnisses sollten alle Sicherheits- und Bedienungsanleitungen gelesen werden.

## 2. Die Anweisungen aufbewahren

Die Sicherheits- und Bedienungsanleitungen sollten fünftigen Bezug aufbewahrt werden.

## 3. Warnungen beachten

Die Warnungen auf dem Erzeugnis und in den Bedienungsanleitungen sollten beachtet werden.

## 4. Anweisungen befolgen

Alle Bedienungsanleitung- und Verwendungsanweisungen sollten befolgt werden.

## 5. Reinigung

Den Stecker des Geräts vor Reinigung aus der Steckdose ziehen. Keine flüssigen Reinigungsmittel oder Aerosolreiniger verwenden. Zum Reinigen einen feuchten Lappen verwenden.

## 6. Zubehör

Nur vom Hersteller des Erzeugnisses empfohlenes Zubehör verwenden, da es sonst zu Störungen kommen kann.

## 7. Wasser und Feuchtigkeit

Dieses Erzeugnis nicht in der Nähe von Wasser verwenden - z.B., in der Nähe einer Badewanne, eines Waschbeckens, einer Küchenspüle, eines

Waschzubehers, in einem nassen Keller, in der Nähe eines Schwimmbeckens usw.

## 8. Aufstellung

Das Erzeugnis nicht auf einen instabilen Wagen, Stand, Dreifuß, Träger oder Tisch stellen.

Das Erzeugnis kann sonst herunterfallen und ein Kind oder einen Erwachsenen schwer verletzen.

Außerdem kann das Gerät schwer beschädigt werden. Nur mit einem Wagen, Stand, Dreifuß, Träger oder Tisch verwenden, der vom Hersteller empfohlen oder mit dem Erzeugnis verkauft worden ist. Für jegliche Anbringung sollten die Anweisungen des Herstellers befolgt werden, und das vom Hersteller empfohlene Anbringungszubehör sollte verwendet werden.

## 9. Eine Kombination von Erzeugnis und Wagen sollte vorsichtig bewegt werden

Schneller Halt, übermäßige Krafteinwirkung und unebene Oberflächen können Umkippen der Kombination von Erzeugnis und Wagen verursachen.

## 10. Ventilation

Schlitze und Öffnungen im Gehäuse dienen der Ventilation. Sie sind für zuverlässigen Betrieb des Gerätes und Schutz vor Überhitzung

erforderlich und dürfen nicht blockiert oder abgedeckt werden.

Die Öffnungen sollten niemals dadurch blockiert werden, daß, das Gerät auf ein Bett, ein Sofa, einen Teppich oder eine ähnliche Oberfläche gestellt wird.

Das Gerät sollte nur dann in Einbauinstallation wie in einem Bücherschrank oder einem Gestell verwendet werden, wenn angemessene Ventilation vorgesehen ist bzw. Die Anweisungen des Herstellers befolgt worden sind.

### **11. Stromversorgung**

Dieses Erzeugnis sollte nur an der auf dem Typenschild angegebenen Stromversorgungsart betrieben werden. Wenn Sie nicht sicher sind, was für eine Stromversorgung Sie haben, so wenden Sie sich bitte an Ihren Erzeugnishändler oder an das lokale Elektrizitätswerk. Beziehen Sie sich für Batteriebetrieb oder andere Stromquellen vorgesehene Erzeugnisse bitte auf die Bedienungsanleitungen.

### **12. Erdung oder Polarisierung**

Dieses Erzeugnis ist mit einem Schutzkontaktstecker mit drei Leitern ausgerüstet, mit einem Erdungskontakt. Dieser Stecker paßt

nur in ein schuko-Steckdose. Dies ist eine Sicherheitsmaßnahme. Wenn Sie den Stecker nicht in die Steckdose stecken können, so wenden Sie sich bitte an ihren Elektriker, damit er die veraltete Schutz des Schutzkontaktsteckers unwirksam.

### **13. Netzkabelschutz**

Netzkabel sollten so verlegt werden, daß möglichst nicht darauf getreten wird und daß sie nicht eingeklemmt werden, mit besonderer Beachtung der Kabel an Stackern, Verlängerungskabeln und dem Austritt des Kabels aus dem Erzeugnis.

### **14. Blitzschlag**

Für zusätzlichen Schutz des Erzeugnisses während eines Gewitters oder bei Nichtverwendung für lange Zeit den Stecker aus der Steckdose ziehen. Dies verhütet Beschädigung durch Blitzschlag und Netzspannungsstöße.

### **15. Überlastung**

Wandsteckdosen, Verlängerungskabel und eingebaute Bequemlickeitssteckdosen nicht überlasten, da dies Feuer oder elektrischen Schlag verursachen kann.

## **16. Eindringen von Fremdkörpern und Flüssigkeit**

Niemals Objekte irgendwelcher Art durch die Öffnungen in das Gerät schieben, da diese unter hoher Spannung stehende Teile berühren oder kurzschließen können, wodurch es zu Feuer oder elektrischem Schlag kommen kann. Niemals Flüssigkeiten irgendwelcher Art auf das Erzeugnis verschütten.

## **17. Entflammbare und explosive Substanzen**

Vermeiden Sie Verwendung dieses Erzeugnisses an Orten mit Gasen bzw. entflammbaren oder explosiven Substanzen in der direkten Umgebung.

## **18. Starke stöße oder Vibrationen**

Setzen Sie das Erzeugnis beim Transport nicht starken Stößen oder Vibrationen aus.

## **19. Wartung**

Versuchen Sie nicht, dieses Erzeugnis Selbst zu warten, da Sie sich durch Öffnen bzw. Entfernen von Abdeckungen hohen Spannungen und sonstigen Gefährdungen aussetzen können. Beziehen Sie sich für jegliche Wartung auf qualifiziertes Wartungspersonal.

## **20. Beschädigung, die Wartung erfordert**

Ziehen Sie den Stecker dieses Erzeugnisses aus der Steckdose und wenden Sie sich an

qualifiziertes Wartungspersonal, wenn eine der folgenden Bedingungen vorliegt:

- a. Wenn das Netzkabel oder der Stecker beschädigt ist.
- b. Bei Eindringen von Flüssigkeit oder Fremdkörpern in das Gerät.
- c. Wenn das Erzeugnis Regen oder Wasser ausgesetzt worden ist.
- d. Wenn das Erzeugnis bei Befolgen der Bedienungsanleitungen nicht normal funktioniert.  
Nur die Regelelemente verstellen, die in den Bedienungsanleitungen behandelt werden, da unangemessene Einstellung anderer Regelelemente Beschädigung verursachen kann und oft beträchtliche Arbeit durch einen qualifizierten Techniker erfordert, um das Erzeugnis wieder, zu normalem Betrieb zurückzubringen.
- e. Wenn das Erzeugnis fallen gelassen oder beschädigt worden ist.
- f. Wenn das Erzeugnis eine klare Änderung in der Leistung zeigt-dies weist darauf hin, daß Wartung erforderlich ist.

## **21. Ersatzteile**

Wenn Ersatzteile erforderlich sind, darauf achten, daß der Wartungstechniker nur die vom Hersteller festgelegten Ersatzteile oder Teile mit den gleichen Charakteristiken wie die ursprünglichen Teile verwendet. Unautorisierte Ersatzteile können Feuer, elektrischen Schlag oder sonstige Gefährdungen verursachen.

## **22. Sicherheitsprüfung**

Bitten Sie den Wartungstechniker nach der Vollendung von Wartung oder Reparaturarbeiten an diesem Erzeugnis um die Durchführung von Sicherheitsprüfungen, um zu bestimmen, daß das Erzeugnis im angemessenen Betriebszustand ist.

## **23. Anbringung an der Wand oder an der Decke**

Das Erzeugnis sollte nur entsprechend den Empfehlungen des Herstellers an einer Wand oder an der Decke angebracht werden.

## **24. Wärme**

Das Erzeugnis sollte fern von Wärmequellen wie Radiatoren, Heizwiderständen, Öfen und anderen Wärme erzeugenden Erzeugnissen (einschließlich Verstärkern) aufgestellt werden.

# MISES EN GARDE IMPORTANTES

## 1. Lire les instructions

Lire toutes les instructions de sécurité et de fonctionnement avant de faire fonctionner l'appareil.

## 2. Conserver ces instructions

Conserver les instructions de sécurité et de fonctionnement à des fins de référence ultérieure.

## 3. Tenir compte des avertissements

Tous les avertissements qui figurent sur l'appareil et dans le mode d'emploi devront être respectés.

## 4. Observer les instructions

Observer toutes les instructions de fonctionnement et d'utilisation.

## 5. Nettoyage

Avant de procéder au nettoyage, débrancher l'appareil de la prise secteur. Ne pas utiliser de produits de nettoyage liquides ou en aérosol. Nettoyer l'appareil avec un chiffon humide.

## 6. Fixations

Ne pas utiliser de fixations non recommandées par le fabricant de l'appareil car elles pourraient être source de danger.

## 7. Eau et humidité

Ne pas utiliser l'appareil à proximité d'eau - ar exemple près d'une baignoire, d'un lavabo, d'un évier

ou d'un bac à lessive, dans un sous-sol humide, ou près d'une piscine, etc.

## 8. Accessoires

Ne pas placer l'appareil sur un chariot, un socle, un pied, un support ou une table instables. L'appareil pourrait tomber, blessant grièvement des enfants ou des adultes, et étant sérieusement endommagé.

Utiliser exclusivement le chariot, le socle, le pied, le support ou la table recommandés par le fabricant, ou vendus avec l'appareil. Pour tout montage de l'appareil, respecter les instructions du fabricant, et utiliser à cette fin l'accessoire de montage recommandé par le fabricant.

## 9. L'appareil monté sur son chariot devra être déplacé avec précaution

Des arrêts brusques, une force excessive et des surfaces irrégulières pourraient provoquer le renversement de l'ensemble appareil-chariot.

## 10. Ventilation

Les fentes et les ouvertures du coffret sont prévues pour la ventilation ainsi que pour garantir un fonctionnement en toute sécurité de

l'appareil et le protéger de toute surchauffe, et ces ouvertures ne devront donc être ni obstruées ni recouvertes. Ne jamais obstruer les ouvertures en placant l'appareil sur un lit, un sofa, un tapis ou toute surface similaire. Ne jamais placer l'appareil dans un support confiné, par exemple une bibliothèque ou une étagère, sans ventilation suffisante ou sans respecter les instructions du fabricant.

#### **11. Sources d'alimentation**

L'appareil devra être alimenté exclusivement sur le type d'alimentation indiqué sur l'étiquette signalétique. Si l'on n'est pas sûr du type d'alimentation du local, consulter le revendeur de l'appareil ou la compagnie d'électricité locale. Pour les appareils qui fonctionnent sur batterie ou sur d'autres sources, voir le mode d'emploi.

#### **12. Mise à la terre ou polarisation**

L'appareil est doté d'une fiche trifilaire avec mise à la terre, dont la troisième broche assure la mise à la terre. Cette fiche ne rentrera que dans les prises trifilaires de mise à la terre. Ceci est une mesure de sécurité. Si la fiche ne rentre pas dans la prise, faire remplacer la prise défectueuse par un électricien.

Ne pas rendre vaine la mesure de sécurité assurée par cette prise avec mise à la terre.

#### **13. Protection du cordon d'alimentation**

Acheminer les cordons d'alimentation de façon qu'on ne risque pas de marcher dessus ou de les coincer sous un objet placé dessus ou contre eux.

Faire particulièrement attention aux fiches des cordons, à la proximité des prises, et à l'endroit où ils ressortent de l'appareil.

#### **14. Foudre**

Pour renforcer la protection de l'appareil pendant un orage, ou si l'on s'en éloigne ou qu'on reste longtemps sans l'utiliser, le débrancher de la source d'alimentation. Ceci permettra d'éviter tout dommage de l'appareil dû à la foudre et aux surtensions de ligne.

#### **15. Surcharge**

Ne pas surcharger les prises, rallonges et prises multiples car cela pourrait entraîner un risque de feu ou de choc électrique.

#### **16. Pénétration d'objets et de liquides**

Ne jamais enfoncer d'objets d'aucune sorte dans les ouvertures de l'appareil car ils pourraient toucher des points de tension dangereuse ou court-circuiter des pièces, ce qui pourrait

provoquer un feu ou un choc électrique. Ne jamais renverser de liquide d'aucune sorte sur l'appareil.

### **17. Substances inflammables et explosives**

Eviter d'utiliser l'appareil en présence de gaz, ainsi qu'à proximité immédiate de substances inflammables et explosives.

### **18. Chocs ou vibrations violents**

Lorsqu'on transporte l'appareil, ne pas le soumettre à des chocs ou des vibrations violents.

### **19. Réparations**

Ne pas tenter de réparer l'appareil soi-même car le fait d'ouvrir ou de retirer les caches risque d'exposer l'utilisateur à des tensions dangereuses notamment. Confier toute réparation à un personnel qualifié.

### **20. Dommages nécessitant réparations**

Débrancher l'appareil de la source d'alimentation et confier les réparations à un personnel qualifié dans les cas suivants:

- a. Lorsque le cordon d'alimentation ou sa fiche sont endommagés
- b. Si du liquide s'est renversé sur l'appareil ou que des objets sont tombés dedans
- c. Si l'appareil a été exposé à la pluie ou à l'eau.

d. Si l'appareil ne fonctionne pas normalement lorsqu'on observe les instructions d'utilisation.

Ne régler que les commandes couvertes par le mode d'emploi ; en effet, un réglage incorrect des autres commandes pourrait entraîner des dommages et nécessiteront souvent des travaux de réparation coûteux par un technicien qualifié pour remettre l'appareil en état de marche.

e. Si l'appareil est tombé ou qu'il a été endommagé.

f. Si l'appareil affiche une nette modification de ses performances, cela signifie qu'il a besoin d'être réparé.

### **21. Pièces de rechange**

Si l'on a besoin de pièces de rechange, veiller à ce que le technicien de réparation utilise exclusivement les pièces de rechange spécifiées par le fabricant ou des pièces ayant les mêmes caractéristiques que les pièces d'origine. Les pièces de rechange non autorisées risquent de provoquer un feu, un choc électrique et autres dangers.

## **22. Vérificaton de sécurité**

Après tout travail d'entretien ou de réparation de l'appareil, demander au technicien de réparation d'effectuer les vérifications de sécurité pour s'assurer que l'appareil est en bon état de marche.

## **23.Montage au mur ou au plafond**

L'appareil ne pourra être monté au mur ou au plafond que de la manière recommandée par le fabricant.

## **24. Chaleur**

Eloigner l'appareil des sources de chaleur, telles que radiateurs, appareils de chauffage, cuisinières, et de tour produit engendrant de la chaleur (y compris les amplificateurs).

# Table of contents

● IMPORTANT SAFETY INSTRUCTUIONS	· · A
● Table of contents	· · · · · L
● Standard composition	· · · · · 1
● Overview	· · · · · 1
● Features	· · · · · 2
● Notes to users	· · · · · 3
Important safety notes	· · · · · 3
Operating considerations	· · · · · 3
CCD properties	· · · · · 4
● Rear panel facilities	· · · · · 5
● LENS	· · · · · 6
Lens selection	· · · · · 6
● Video signal type lens adjustment	· · · · · 7
● Camera mounting	· · · · · 8
● System example	· · · · · 9
● Menu screen operation	· · · · · 10
Menu Structure	· · · · · 10
MAIN MENU	· · · · · 13
SUB MENU 1	· · · · · 16
SUB MENU 2	· · · · · 19
ALC	· · · · · 21
SPECIAL SET	· · · · · 23
LENS	· · · · · 24
WHITE GATE	· · · · · 27
LEVEL	· · · · · 28
MASKING	· · · · · 29
GAMMA	· · · · · 30
DTL	· · · · · 31
DTL-SUB	· · · · · 33
EXT TRIGGER	· · · · · 34
OUTPUT/SYNC	· · · · · 39
FILE SET	· · · · · 41
OTHER FUNC	· · · · · 42
ID/TITLE	· · · · · 44
● How to Attain Better images	· · · · · 46
Black Balance Adjustment	· · · · · 46
White Balance Adjustment	· · · · · 47
Real time Auto White	· · · · · 49
Auto Shading Correction	· · · · · 49
ALC (Auto level control)	· · · · · 50
Long-Time Store Mode	· · · · · 52
● RC-Z3 remote control panel	· · · · · 54
RC-Z3 panel facilities	· · · · · 56
● Function Selection by internal Switch Setting	63
● Connectors	· · · · · 64
● Specifications	· · · · · 67
● Input/Output Signals	· · · · · 70
● Major accessories	· · · · · 72
● Dimensions	· · · · · 72

## Standard composition

Check when unpacking.

Camera, HV-D20P .....	1
Power plug, R03-P3F (JPR0034*) .....	1
Lens plug, E4-191J-100 (JPE0001*) .....	1
Operation Manual .....	1

\* Part code

## Overview

The HV-D20P is a three CCD color camera combining high picture quality and high stability with the convenience of C mount optics. CCD size is 1/2-inch and each is comprised of 470,000 picture elements. The circuits from processor to encoder are digitized and contained on a single LSI chip.

Hitachi's extensive experience in broadcast and industrial color cameras has lead to an exclusive 14-bit digital processing technology that provides a host of important functions in a newly developed LSI device.

The high quality signal processing and image compensating functions were unattainable in earlier analog cameras. The versatile C mount also allows use with a broad range of optical systems and opens up applications in a wide variety of fields.

# Features

- **Single chip LSI camera signal processor**

Hitachi's leading edge processing technology (0.18  $\mu$  m, internal core 1.8V drive, and 3 million gates) is contained on a single newly developed ultra LSI chip. The system is compact and consumes very little power. Also, the 12-bit A/D converter and 14-bit internal processor provide high signal to noise ratio and wide dynamic range.

- **C mount**

The camera uses a C mount lens, which is the de facto standard in the industry. A built-in flangeback adjusting mechanism allows use with different types of optical systems.

**Note** : Some lenses cannot be used. Check before use. See page 6 when using lens.

- **High quality picture**

Three 1/2-inch 470,000 pixel CCDs with high sensitivity microlenses are mated to prism optics using high precision matching technology. Accelerated digital luminance signal processing is used to deliver a horizontal resolution of 800 TV lines (luminance channel).

A new digital noise reduction system provides 62 dB signal to noise ratio. Clear low noise images are obtained even in high gain mode.

- **Auto shading compensation (ASC)**

Color shading incurred when using a C mount lens is automatically compensated (attenuated). Two modes of shading are provided and can be selected according to the cameras application, a vertical color shading mode or a two-dimensional luminance-shading mode.

- **Bi-directional data communication**

The camera can be connected to a personal computer via RS-232C for two-way data communications to provide finely detailed camera control. An identification (ID) code can be assigned to each camera in a system and allow remotely controlling multiple cameras from a single computer.

## Notes to users

### Important safety notes

- Use this camera with a 12 VDC power supply.
- Observe that flammable objects, water or metal do not enter the camera interior. These may lead to failure or accident.
- Do not modify the camera or use the camera with external covers removed. These may cause failure, void any warranties and pose a safety hazard.
- Stop using the camera at the approach of an electrical storm (thunder audible). Protect the camera from rain if using it outdoors.
- In event the camera shows any abnormality, switch off the camera and disconnect the power cord. Contact a Hitachi Denshi service representative.

### Operating considerations

#### ● Power supply

Check that the supplied voltage is between 10.5 and 15 VDC. Inadequate voltage can affect color fidelity and cause noise, while voltage over 15 V can damage the camera.

#### ● Connectors

Confirm the power is off before connecting or disconnecting a signal cable. Grasp connectors by the body, not the attached wires.

#### ● Lens

The correct lens is important for deriving optimum performance from the camera. Consult a Hitachi Denshi dealer for a selection of fine lenses according to the application.

#### ● Installation and storage sites

The following types of environment can impair performance, lead to damage, pose safety hazards and shorten the useful life of the camera. Select the sites for installing the storing the camera carefully.

- Direct sunlight, rain or snow
- Flammable or corrosive gasses
- Very hot or cold (beyond -10 to 45 °C operating, -20 to 60 °C storage)
- Humid or dusty
- Exposed to vibration or shock
- Strong electrical or magnetic fields
- Exceptionally strong light

### Continuous operation

In situations where the camera is used continuously for long periods of time, the ambient temperature should be kept below 40 °C in order to avoid accelerated deterioration of internal parts and to derive maximum long-term reliability.

## Cleaning

- A photographer's blower or lens brush can be used for clearing dust from the lens and optical filters.
- Wipe dust from the case with a soft dry cloth. If soiling is severe, moisten the cloth with a solution of neutral detergent. Afterwards, wipe the cover with a dry cloth.
- Do not use petroleum distillates, alcohol or spray type cleaners.

## Transportation

Remove the lens (install lens mount cap) and other attachments. Pack the camera carefully in its original or equivalent container. Use ample cushioning to protect the camera from physical shock.

## CCD properties

The following phenomena are inherent to a charge coupled device imaging element and do not indicate malfunction.

### 1) Smear and blooming

Vertical bands are visible when a strong light enters the scene. Adjust the camera aiming direction carefully to avoid strong direct or

reflected light.

### 2) Fixed pattern noise

High ambient temperature can cause fixed pattern noise to appear throughout the scene.

### 3) Moire

Interaction between patterns can produce an additional "phantom" pattern to appear. The CCD picture elements (pixels) are arranged in a pattern, which can interact with a pattern in the scene (e.g., a performer wearing a finely striped necktie) to result in a Moire pattern. The effect should be considered when selecting costumes, props and other scene elements.

### 4) Ghosting

Strong direct or reflected light near an object of interest can cause ghosting of the object to appear in the picture. The effect is more obtrusive with certain iris settings and lens types. Select the scene layout and camera pointing direction carefully in order to avoid this effect.

# Name and function each section

## MENU button

Press this button to display the camera setup menu. The buttons U, D, L and R provide different functions depending on whether the menu is displayed (MENU mode) or not (DERECT mode).

## VIDEO connector

Outputs a composite video signal(1Vp-75 ohms).

## Pilot lamp

Lights when power is supplied.

## REMOTE connector

Used for connection with the remote control box RC-Z3 or personal computer.

## DC IN connector

The 12V power supply is connected.

## MULTI connector

Output for RGB, Y/R-Y/B-Y, or Y/C and VBS signals.  
Also used for sync signal I/O and external trigger signal input.

## LENS connector

Lens iris control signal connector; connect the iris connector of an auto iris lens.

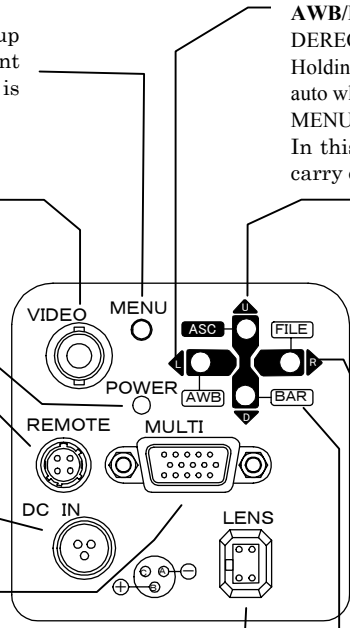

## AWB/L button

### DERECT mode:

Holding down this button for more than two seconds carries out auto white balance (AWB).

### MENU mode:

In this mode, it is allowed to change functional data or carry out each function.

## U button

### DERECT mode:

While holding down this button for more than two seconds and press the D button carries out auto shading compensation (ASC).

### MENU MODE:

Pressing this button moves the cursor up.

## FILE/R button

### DERECT mode:

Selects the scene file. Press once to show the present file name for 1 second. During the display, press again to change the scene file.

### MENU mode:

In this mode, it is allowed to change functional data or carry out each function.

## BAR/D button

### DERECT mode:

Press this button to turn on/off a color bar signal.

### MENU mode:

Pressing this button moves the cursor up.

For details of each connector, refer to the description of connectors (page 64).

# Lens

## CAUTION:

Observe the dimensions of the lens mounting selection as illustrated at the right.

If the dimensions are not observed, do not use such a lens, because the lens and the camera will be damaged.

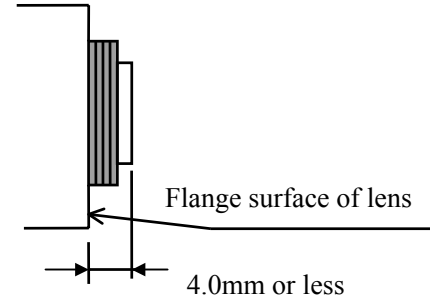

## Lens selection

### 1) Optical characteristics

The proper lens is vital for obtaining full performance from the camera. The exit pupil distance is particularly important for a 3 CCD type camera. If too short, vertical color shading can appear in the picture.

Also, as the lens iris approaches fully open, problems such as loss of + resolution, shading and flare (overall image "white-out") can detract from picture quality. When using in applications that call for open iris, the lenses for 3 CCD are recommended. If another lens is contemplated, check the performance beforehand.

### 2) Auto iris lens

Main types are Video (with self contained iris amplifier) and DC (DC voltage applied to open lens iris) and manual over-ride (e.g., Cosmimar). Lenses without self-contained iris amplifier are not compatible.

Camera settings differ according to the auto iris lens type (see page 24).

**Note:** The HV-D20 uses lens connector wiring prescribed by the EIAJ (Electronic Industries Association of Japan). Refer to page 65

# Video signal type lens adjustment

Adjustment is required after replacing the lens or if using the camera for the first time.

## 1) Preparation

- (1) Release the AGC mode (set the main menu AGC to OFF).
- (2) If the light source has a flicker component (e.g., fluorescent or mercury lighting), change the electronic shutter mode (Sub-menu 1 Shutter or Variable) to reduce the flicker.
- (3) Adjust the white balance.

## 2) Adjustment

Hold the U button depressed and press Setup for about 2 seconds to display the Special Set menu. Change to the Lens screen and check the Lens Type setting. If DC, change this to Video.

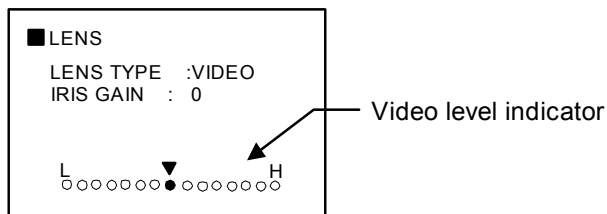

- (1) Set the lens ALC control fully toward the average (Av) position.
- (2) If auto iris hunting occurs, reduce the Iris Gain setting.
- (3) Adjust the lens level control to where the center circle is positioned at the video signal level indicator triangle mark.

If the camera video signal detection level is optimum, the triangle mark is center. If larger than optimum, the triangle marker to the right of H is moved and if lower, the triangle mark to the left of L is moved.

## 3) Lens adjustment difficult or impossible

- (1) Video signal level indication unstable  
Unstable indication can occur if the light source has a flicker component (e.g., fluorescent or mercury lighting), change the electronic shutter mode (Sub-menu 1 shutter or Variable) to reduce the flicker.
- (2) Lens Level control fully at Hi, but auto iris inoperative Reduce the Iris Gain setting.
- (3) Lens Level control fully at Low, but auto iris inoperative Increase the Iris Gain setting.

(4) Auto iris operates, but scene is dark. Even if lens Level control is adjusted, the triangle mark to the left of the H mark is moved.

Boost the gain. Set main menu Gain to 1–24 dB in order to raise the sensitivity.

**Note:** The video signal level indicator sensitivity is high in order to increase lens adjustment accuracy. Operate the lens Level control slowly.

## Camera mounting

The camera is provided with threaded screw holes at the top and bottom. These allow mounting to either a tripod or a mounting bracket.

Screw type: U 1/4-20

Length: 4.5 to 6 mm

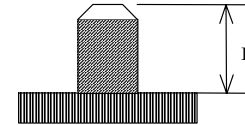

Screws longer than 6 mm can cause internal damage, while less than 5 mm prevents secure fastening and risks dropping to cause damage and injury.

# System example

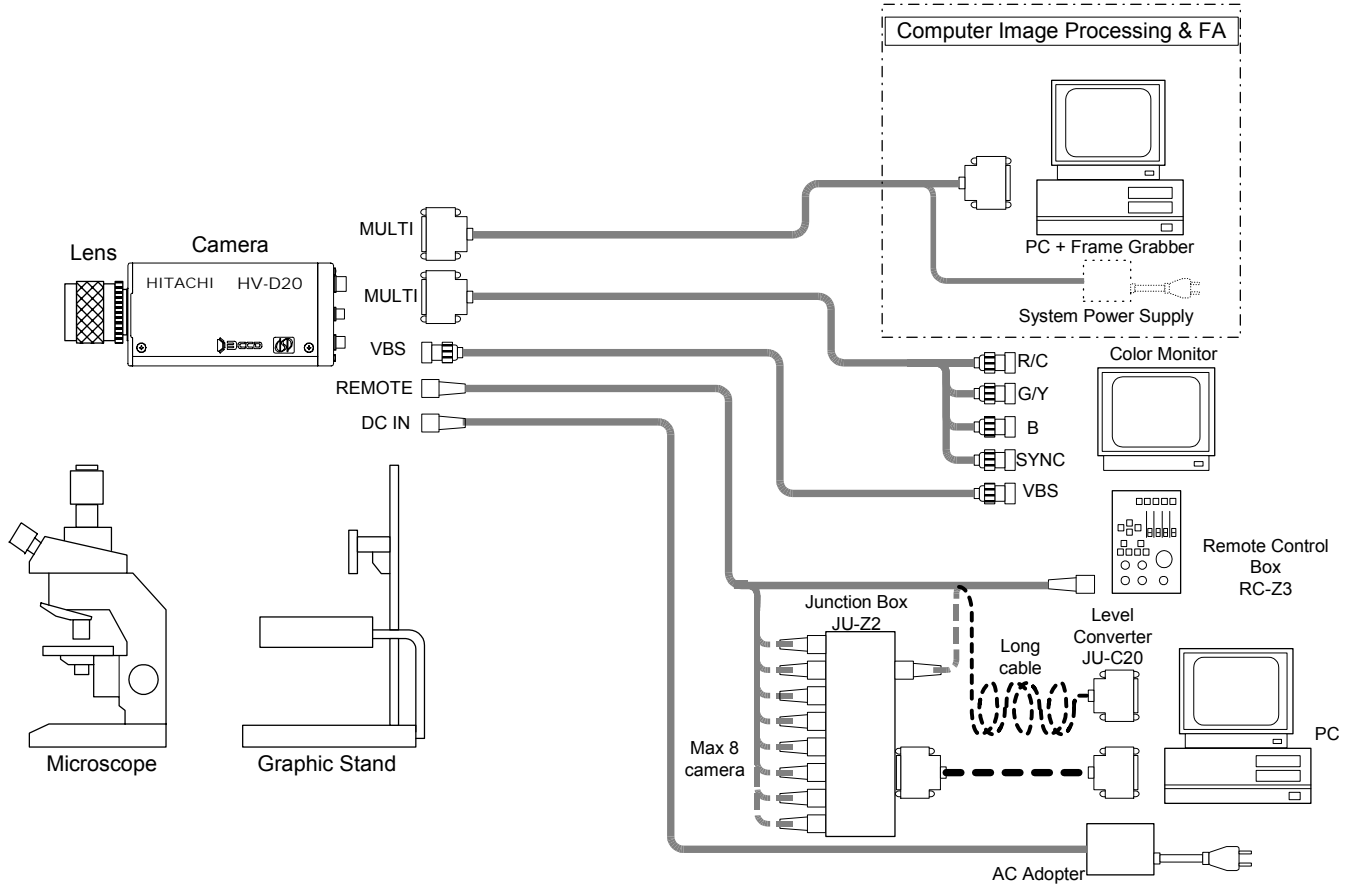

# Menu Screen Operation

## 1. Menu Structure

For settings in the camera, the MAIN and SPECIAL menus are available.

### 1-1 MAIN Menu Structure

Press the MENU button and MAIN MENU appears on the screen to indicate the main menu mode. Again press the MENU button to extinguish the menu and enter the direct mode. There are a main function setup menu and three sub-menus, which are arranged hierarchically as shown below. On the MAIN menu, bring the cursor to SUB MENU 1, SUB MENU 2 or ALC and press the R button, and the desired subsidiary menu will come up. To return to the MAIN MENU from the SUB menu 1, SUB menu 2 or ALC, bring the cursor to the top line (title line of SUB MENU 1, SUB MENU 2 or ALC) and press the L button.

On each menu screen, bring the cursor to any desired item using the U or D button. For mode change/data setting, use the L or R button.

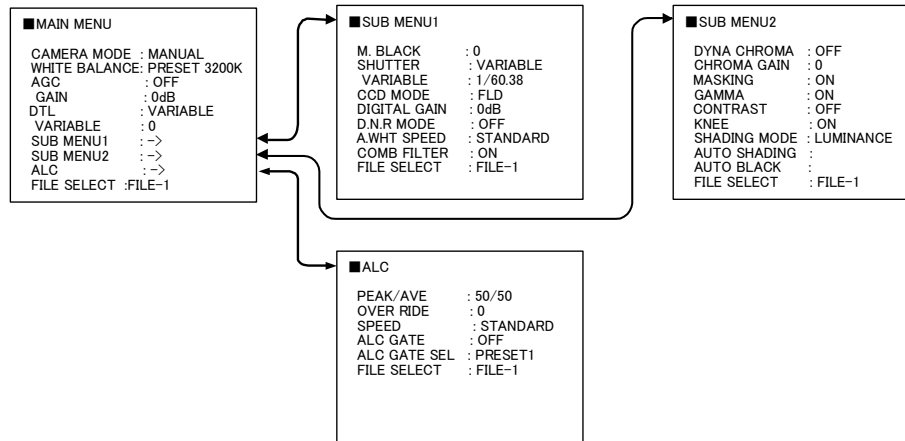

## 1-2 SPECIAL Menu Structure

To select the SPECIAL SET mode, press the MENU button for 2 seconds while holding down the U button. Thus, the SPECIAL SET menu can be displayed. To return to the DIRECT mode, press the MENU button again. The SPECIAL SET menu indicates a list of items, and each special items subsidiary menus are available. These menus are arranged hierarchically as shown below. On the SPECIAL SET menu, most items have '->' mark at the right side. For these items, press the R button, and the relevant item setup menu will come up. To return to the SPECIAL SET menu, bring the cursor to the top line (title line of each subsidiary menu) and press the L button. On each menu screen, bring the cursor to any desired item using the U or D button. For mode change/data setting, use the L or R button.

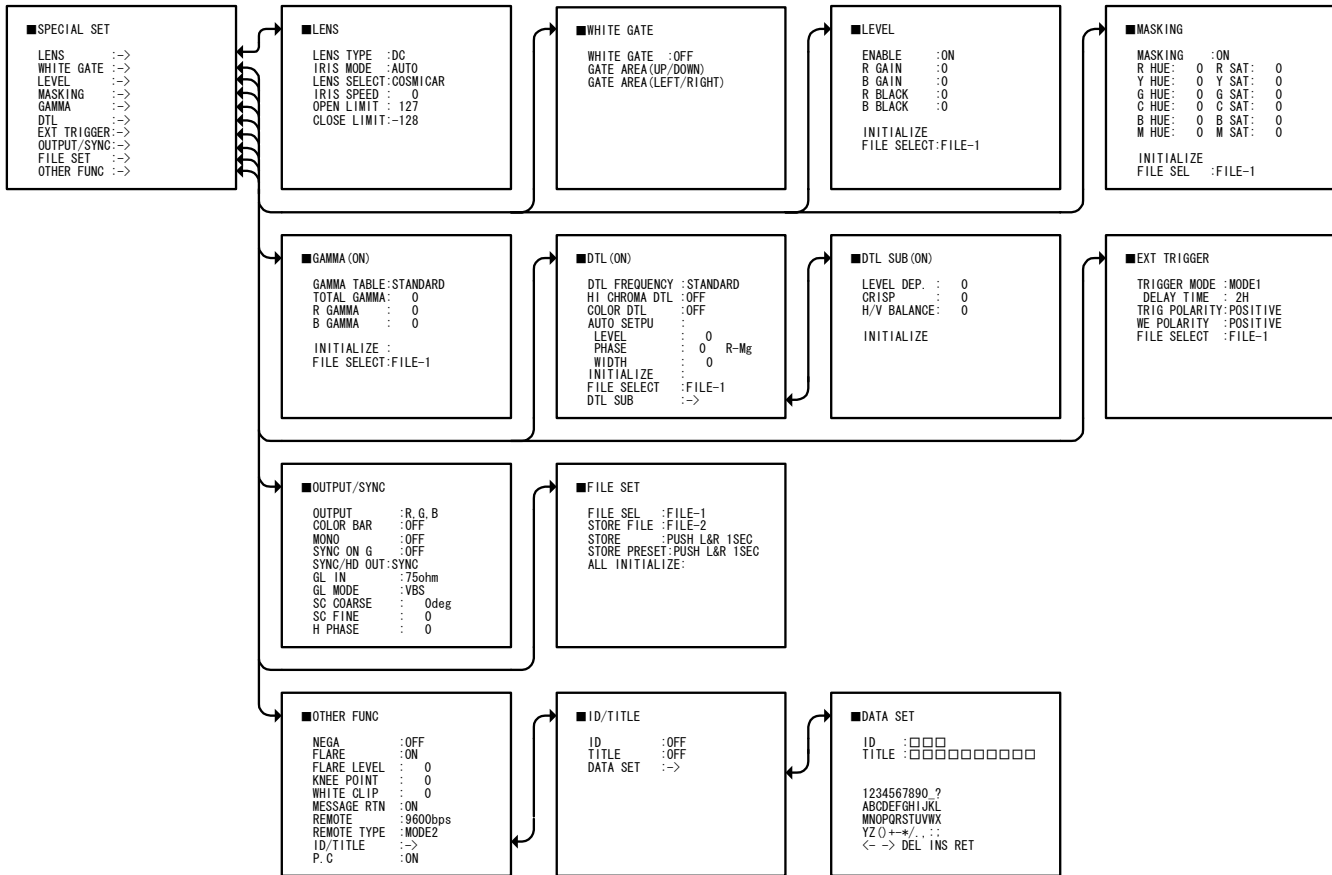

## 2. MAIN MENU

### 1) CAM MODE : Camera mode

- **MANUAL** : Nearly all function modes can be set. Use for detailed settings.
- **AUTO** : Video level and white balance are automatic and a standard picture can be observed without detailed settings.

Asterisk (\*) indicates a fixed setting and the cursor jumps to the next item. The Auto indication flashes when a function is related to the auto mode. At the Lens menu, the shutter mode changes according to the Lens Type setting.

MENU	Function and Mode
	WHITE BALANCE : AUTO
	AGC : ON
SUB MENU 1	SHUTTER : AES (LENS TYPE: DC)
	KNEE : AUTO KNEE
	GAMMA : ON
SPECIAL SET LENS	LENS TYPE : Not settable
	R BLK : Disable
	B BLK : Disable

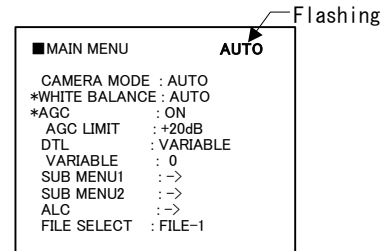

MAIN MENU	AUTO
CAMERA MODE : AUTO	
*WHITE BALANCE : AUTO	
*AGC : ON	
AGC LIMIT : +20dB	
DTL : VARIABLE	
VARIABLE : 0	
SUB MENU1 : ->	
SUB MENU2 : ->	
ALC : ->	
FILE SELECT : FILE-1	

## 2) WHITE BAL : White balance mode

- PRST 3200K : The white balance condition is optimized at a color temperature of 3200K.
- PRST 5600K : The white balance condition is optimized at a color temperature of 5600K.
- MEM: White balance is automatically adjusted by the direct mode AWB button.
- AUTO : The white balance condition is set through real time auto white balancing (automatic tracking white balance).

The adjustment speed can be selected with A.WHITE SPEED of SUB MENU 1.

**Note:** In the Auto CAM mode, white balance is fixed at AUTO.

## 3) AGC : AGC ON/OFF

- ON : Gain is adjusted automatically to compensate for scene brightness.  
The adjustment range is set by Limit from +6 to +24 dB in 1 dB steps.
- OFF : Gain is fixed and manually adjustable in 1 dB steps from 0 to +24 dB.

## 4) DTL : DTL level setup

- OFF : DTL OFF
- LOW : DTL level decrease and a picture becomes soft.
- NORMAL : DTL level is standard.
- HIGH : DTL level increase and a picture becomes sharp.
- VARIABLE : DTL level is VARIABLE value under a line.

The DTL level can be set to in a range of -128 to 127. The degree of contour correction increases in the positive value setting, and it decreases in the negative value setting. For zero (0) setting, hold down both the L and R buttons for approx. two seconds.

5) **SUB MENU 1** : The SUB menu 1 is brought up.

6) **SUB MENU 2** : The SUB menu 2 is brought up.

7) **ALC** : The ALC is brought up.

8) **FILE SELECT** : Select among scene files 1, 2, 3, 4 and PRESET

Camera setting data can be stored in four scene files.

To shoot several scenes with different shooting conditions, it is needed to change settings suitable for each scene. To reduce such troublesome operations, various shooting conditions can be memorized previously to scene files, and the conditions most suitable for a scene can be read and set.

There is a **FILE SELECT** item in the following menu. The function, operation are same. It can memory each setting data of the following **MENU** as the scene file.

MAIN MENU

SUB MENU 1

SUB MENU 2

ALC

SPECIAL SET LEVEL

SPECIAL SET MASKING

SPECIAL SET GAMMA

SPECIAL SET DTL

SPECIAL SET EXT TRIGGER

### 3. SUB MENU 1

#### 1) M. BLACK : Master black level setting

The master black level can be set in a range of -128 to 127. Pressing the R button increases a set value to make the black level higher, and pressing the L button decreases a set value to make the black level lower. For zero (0) setting, hold down both the L and R buttons for approx. one seconds.

#### 2) SHUTTER : Electronic shutter mode

- OFF : Electronic shutter does not operate.
- PRESET : Shutter operates at the Preset speed. Select speed from among 1/60, 1/250, 1/500, 1/100, 1/2000, 1/4000, 1/10000, 1/20000, 1/40000 and 1/100000 second.
- VARIABLE : The shutter speed is VARIABLE value under a line.

a) 8 to 1/30 (1/25 : PAL) : Long-time frame store mode:

4 to 1/30 (1/25 : PAL) : Long-time field store mode

The camera delivers intermittent video signal output. So, to view continuous images, it is required to use the video memory. A clear image can be attained even if the subject is illuminated with a faint light source. As the store time increases, the degree of after-image becomes higher.

**Note** : With an increase in store time, the degree of characteristic pattern noise, white scratch, etc. of the CCD image sensor will become higher.

b) 1/60.38 (1/50.31: PAL) to 1/100,000 : Lock scan mode

When an image of a subject display screen having a different scan frequency is taken, a bright or dark horizontal bar appears to roll up or down the screen. The shutter speed can be adjusted to where the horizontal bars are minimized in the display.

**Note** : If the display screen scanning frequency is less than 60Hz (50Hz PAL), the rolling horizontal bars cannot be stopped. Not settable in the Auto CAM mode.

- 
- **AES** : Auto electronic shutter operates in the Limit range setting. Optimum image level is obtained under strong light conditions. Effectively used for special optical systems such as microscope or fixed iris lens which do not have automatic light adjustment functions. Limit settings can be selected from 1/500 to 1/100000 second

**Note:** AES cannot be used with Video Type Lens. To use AES with a manual iris lens, set the Lens Type to DC and Iris Mode to Manual. If the iris opening is relatively wide in comparison to the DC voltage (manual over-ride lens), set the Lens Type to DC and the Iris Mode to Auto.

**Note:** In the Auto CAM mode and the Lens Type is set to DC, the shutter is set to AES. If Lens Type is set to Video, default is to off.

- **EXT TRIGGER** : External trigger refer to a function for picking up rapidly moving objects by applying a trigger pulse input.  
It is possible to pick up an image with various timing, by the mode that was set in EXT TRIGGER under 1 line.

### 3) **EXT TRIGGER** : external trigger mode

For details of MODE1, MODE2, please refer to Page 35.

**Note:** Please input the trigger pulse signal, after the various kinds mode and polarity of EXT TRIGGER are set up. Please do not draw out cable from a MULTI connector during the external trigger function action.

**4) CCD MODE** : CCD store mode

- **FLD** : The field integration mode operation is performed (for ordinary purpose of application).
- **FRM** : Frame integration mode; although vertical resolution is improved, image lag is slightly increased. Suggested for still images. At AES Shutter mode, camera sensitivity is reduced by about 6 dB.

**5) DIGITAL GAIN** : Digital gain setup

Select from among 0, +6 and +12 dB. Since added to the Main menu Gain setting, maximum increase is 36 dB.

**6) DNR** : Digital noise reduction

Select Off, Mode 1 or Mode 2. Although Mode 2 provides greater noise reduction than Mode 1, image resolution is slightly reduced.

**7) A WHT SPEED** : Sets real-time auto white balance response speed.

- **Standard** : Usual setting
- **Slow** : Slows white balance response. Although usable for general purpose, intended to reduce disturbance with flashing lights of different color temperatures or moving vehicle headlights.

**8) COMB FILTER**

**On:** Reduces cross color (rainbow effect) with striped images (e.g., performer wearing a striped necktie).

**Note:** Less reduction effect in PAL systems, producing a soft image.

**9) FILE SELECT** : Select scene file from among 1, 2, 3, 4 and PRESET.

## 4.SUB MENU 2

**1) DYNA CHROMA** : Dynamic chroma ON/OFF

On setting improves coloration in bright scene components.

**2) CHROMA GAIN** : Level setting in chroma signal

Setting range is -128 to 127. Press R and L to respectively raise or lower the chroma signal level.

Press both L and R for about 2 seconds to set to 0.

**3) MASKING** : Masking ON/OFF

On (standard) setting provides overall picture adjustment at the Special Set Masking menu.

**4) GAMMA** : Gamma ON/OFF

On/off toggle. At Auto Camera Mode, defaults to on.

**5) CONTRAST** : Contrast OFF/LOW/HIGH

Contrast can be set in two steps of Low and High. HIGH enhances the contrast more than Low.

**6) KNEE** : Knee OFF/ON/AUTO

The on setting provides natural gradation in bright portions. At the auto setting, gradation in bright components is automatically optimized even with scene changes.

Knee is fixed to AUTO KNEE in the Auto CAM mode.

**7) SHADING MODE :** Auto shading setting

- **COLOR** : Minimize vertical shading in image. Use for general scenes.
- **LUMINANCE** : Equalizes vertical RGB signal levels. Use for special optics such as microscope or inspection devices.
- **FLAT** : Equalizes overall image RGB signal levels. Effective for microscope perimeter shading and inspection devices.

If shading is large or random, compensation error increases. In such cases, adjust for uniform lighting.

**Note :** The shading correction is ineffective in the trigger mode.

**8) AUTO SHADING**

Press R for automatic shading adjustment. See further description on Page 49.

**9) AUTO BLACK :** Press R for automatic black balance adjustment.

**10) FILE SELECT :** Select scene file from among 1, 2, 3, 4, and PRESET.

## 5. ALC

- 1) **PEAK/AVE** : Set auto level control for Peak or Average in 4 steps of 50/50, 25/75, 18/85 or 0/100. At high Average setting, background may be difficult to see in picture bright components. Increasing the Peak setting may render spotlighted components easier to see.
- 2) **OVER RIDE** : Auto iris level setting  
ALC level setting in range of -128 to 127 (about  $\pm 2$  F stops). Press R and L for respectively higher or lower video level settings. Press both L and R for about 2 seconds to set to 0.
- 3) **SPEED** : AGC and AES response speed
  - SLOW : Slow response to scene light variations. Allows a stable image when a strong light source, e.g., vehicle headlights, enters the scene.
  - STANDARD : Normal setting
  - FAST : Quick response to scene light variations. Use where variations are sudden, such as when changing a microscope magnification.
- 4) **ALC GATE** : ON/OFF toggle
  - ON : Video signal is detected in the ALC Gate area for controlling AGC, lens and auto electronic shutter and ALC.  
  
**Note:** The detect area cannot be seen on the screen, the ALC control functions for the iris gate.
  - OFF : The overall video signal is detected for ALC control
- 5) **ALC GATE SEL** : Select ALC gate pattern  
Select pattern from among Modes 1, 2, 3, 4, 5 and 6. Use according to scene conditions.

**Note:** The detect area shown in the under figure cannot be seen in the screen, the ALC control functions for the iris gate.

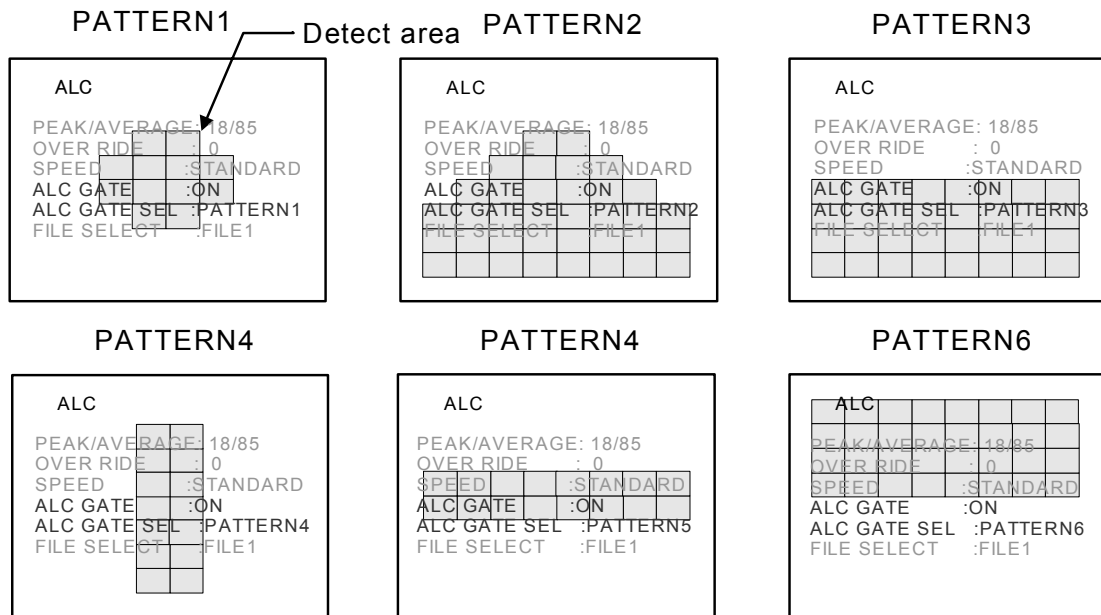

6) **FILE SELECT :** Select scene files from among 1, 2, 3, 4 and PRESET.

## 6. SPECIAL SET

Special menu allows more detailed settings for the camera.

- 1) **LENS** : Change to LENS menu.  
Set for optimum lens operation. Setting is required according to the lens type.
- 2) **WHITE GATE** : hang to WHITE GATE menu.  
White gate position setting.
- 3) **LEVEL** : hang to LEVEL menu.  
Sets R and B black and signal levels.
- 4) **MASKING** : Change to Masking menu.  
Sets 6 vector masking.
- 5) **GAMMA** : Change to GAMMA menu.  
Gamma response, balance and other properties are set.
- 6) **DTL** : Change to DTL menu.  
DTL boost frequency, color, crisp and other properties are set.
- 7) **EXT TRIGGER** : Chainge to EXT TRIGGER menu.  
Sets polarity, video signal output timing, and other properties.
- 8) **OUTPUT/SYNC** : Change to OUTPUT/SYNC menu.  
Camera output signal switching and phase settings during genlock operation.
- 9) **FILE SET** : Change to FILE SET menu  
File operations, such as copying settings between scene files.
- 10) **OTHER FUNC** : Change to OTHER FUNC menu  
Sets positive/negative image switching, communication and other functions.

## 7. LENS

Menu for setting the lens functions

1) **LENS Type** : Sets type of auto iris.

- DC : Iris opens in proportion to a DC control voltage. Also set to DC when not using an automatic iris.
- Video : Lens iris is controlled by the video signal.

**Note:** Auto electronic shutter (AES) cannot be used in the Video mode.

The menu screen changes according to the Lens Type setting.

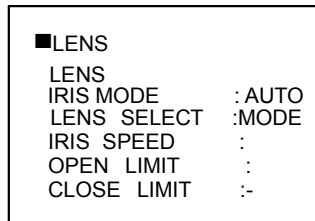

DC mode menu

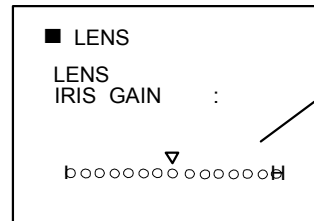

Video level indicator

VIDEO mode menu

2) **IRIS MODE** : Sets lens iris mode (Lens Type is DC mode).

- Auto : Setting for using auto iris.

**Note:** Be sure to set the Open Limit and Close Limit when using the camera for the first time or after replacing the lens.

- Manual: Setting for manual iris and special optics, e.g., microscope.

**Note:** Be sure to set the Iris Mode when combining AGC and AES.

**3) LENS SELECT** : Sets iris control voltage (Lens Type is DC mode).

- Mode 1 : Control voltage is 1.5 to 5.5 V (e.g., Cosmicar with manual over-ride).
- Mode 2 : Control voltage is 2.5 to 7.5 V.

**4) IRIS SPEED** : Sets auto iris speed (Lens Type is DC mode).

Set in a range of 1 to 15 where hunting is not produced. Press R to increase and L to decrease the setting. Hold button depressed for continuous change. Simultaneously press R and L for about 2 seconds to set to 8.

**5) OPEN Limit** : (Lens Type is DC mode.)

Set to where the camera recognizes the iris is fully open. Observe the iris and adjust in the range from 1 to 127 to precisely where the iris is fully open. Press R to increase and L to decrease the setting. Press the L and R buttons simultaneously for about 2 seconds to set to 127 for Others.

Since picture quality deteriorates as the iris approaches fully open, Open Limit can be set to where this does not occur.

- Notes:**
- 1) Before this adjustment, set AGC to OFF and Shutter to Off. Return the previous settings after adjusting.
  - 2) Open Limit needs to be set properly for normal AGC coupled operation.

**6) CLOSE Limit :** (Lens Type is DC mode.)

Observe the iris and adjust to precisely the largest value (smallest diameter). The setting range is from -128 to -1. Press R to increase and L to decrease the setting. Press L and R buttons simultaneously for about 2 seconds to set to -85 for Cosmimar or to -65 for Others.

**Notes:**

1. Before this adjustment, set AGC to OFF and Shutter to Off. Return the previous settings after adjusting.
2. Close Limit needs to be set properly for normal AES coupled operation.

**7) IRIS GAIN :** Iris control voltage gain adjustment (Lens Type is Video mode).

Adjustment is required when replacing a Video type lens or if using the camera for the first time. The setting range is from -10 to 10. Press R to increase and L to decrease the setting. Simultaneously press the L and R buttons for about 2 seconds to set to 0.

Next adjust the lens Level control to highlight the central marker of the video signal level indicator. Adjust the lens level control to where the circle is positioned at the video signal level indicator triangle mark. Refer to description of video signal type lens adjustment (page 8).

If auto iris does not operate even at the Hi or Low extremes of the Level setting, adjust the Iris Gain setting.

**Notes:** Before adjusting Iris Gain, be sure to set the AGC to OFF, and Over-ride to 0. Adjustment is incorrect in the AGC mode. After adjusting, return the previous settings.

## 8. WHITE GATE

Sets the area (window) position for use as white balance control data. Adjust the window to a white or gray monochrome portion of the screen.

### 1) WHITE GATE : White gate ON/OFF

- ON : In real time auto white balance operation or execution of memory auto white balance, a video signal appearing in the window on screen is detected for white balancing.  
In the MENU mode, the window is presented over the video signal. In the DIRECT mode, the window is not displayed but white balance control is conducted by the white gate function.
- OFF : A video signal of the entire image is detected for carrying out white balance control.

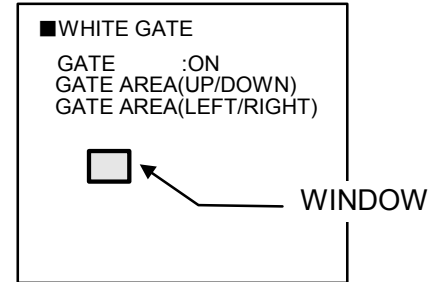

### 2) GATE AREA<UP/DOWN> : The window can be shifted up/down.

To shift the window up, press the R button. To shift it down, press the L button.

### 3) GATE AREA<LEFT/RIGHT> : The window can be shifted left/right.

To shift the window rightward, press the R button. To shift it leftward, press the L button.

## 9. LEVEL

This menu screen allows you to set up a black level and gain of R/B video signal.

**1) ENABLE** : Level control ON/OFF setting.

**2) R GAIN** : R gain level setting

The allowable setting range is -128 to 127.

Pressing the R button increases a numeric value to make the R video signal gain higher. Pressing the L button decreases a numeric value to lower the R video signal gain. For 0 (zero) setting, hold down both the L and R buttons for approx. two seconds.

**3) B GAIN** : B gain level setting

The allowable setting range is -128 to 127.

Pressing the R button increases a numeric value to make the B video signal gain higher. Pressing the L button decreases a numeric value to lower the B video signal gain. For 0 (zero) setting, hold down both the L and R buttons for approx. two seconds.

**4) R BLK** : R black level setting

The allowable setting range is -128 to 127.

Pressing the R button increases a numeric value to make the R video signal black level higher. Pressing the L button decreases a numeric value to lower the R video signal black level. For 0 (zero) setting, hold down both the L and R buttons for approx. two seconds.

**5) B BLK** : B black level setting

The allowable setting range is -128 to 127.

Pressing the R button increases a numeric value to make the B video signal black level higher. Pressing the L button decreases a numeric value to lower the B video signal black level. For 0 (zero) setting, hold down both the L and R buttons for approx. two seconds.

**Note:** In case of CAM MODE: AUTO, numeric values of R BLK, B BLK become ineffective.

**5) Initialize** : Returns level menu settings to preset values. Simultaneously press L and R for about 2 seconds.

**6) File select** : Selects scene files 1 - 4 and preset.

## 10. MASKING

Menu for setting the masking.

- 1) **MASKING**: MASKING ON/OFF setting
- 2) **R HUE**: Change red color phase
- 3) **Y HUE**: Change yellow color phase
- 4) **G HUE**: Change green color phase
- 5) **C HUE**: Change cyan color phase
- 6) **B HUE**: Change blue color phase
- 7) **M HUE**: Change magenta color phase

The above items can be set in the range from -128 to +127. Respectively press the R button to increase and the L button to decrease the vector color hue as indicated in the figure. Each item can be set to 0 by simultaneously pressing the L and R buttons for about 2 seconds.

- 8) **R SAT**: Increase red color level
- 9) **Y SAT**: Increase yellow color level
- 10) **G SAT**: Increase green color level
- 11) **C SAT**: Increase cyan color level
- 12) **B SAT**: Increase blue color level
- 13) **M SAT**: Increase magenta color level

The above items can be set in the range from -128 to 127. Respectively press the R button to increase and the L button to decrease the color level. Each item can be set to 0 by simultaneously pressing the L and R buttons for about 2 seconds.

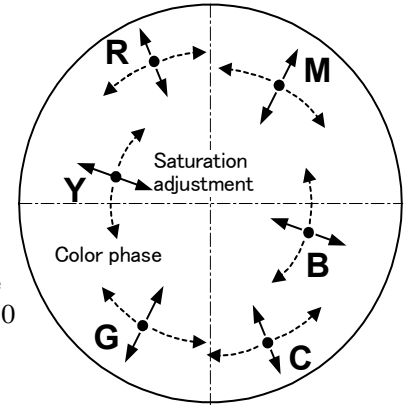

- 
- 14) **Initialize** : Returns level menu settings to preset values. Simultaneously press L and R for about 2 seconds.
  - 15) **File select** : Selects scene files 1 - 4 and preset.

## 11. GAMMA

Menu for setting the gamma parameters. If dark component contrast is inadequate, adjusting the gamma parameters allows detailed adjustment of the Sub-menu 2 Contrast (Off, Low, High).

1) **GAMMA TABLE** : Sets gamma rising slope.

- Low : Dark component gradation reduced.
- Standard : Standard setting
- High : Dark component gradation increased.

2) **TOTAL GAMMA** : Sets total (R, G and B) gamma point

Setting range is from -128 to 127. Press R to raise and L to lower RGB video signal gamma point. Simultaneously press the L and R buttons for about 2 seconds to set to 0.

3) **R ADJUST** : Sets red gamma point.

Setting range is from -128 to 127. Press R to raise and L to lower red video signal gamma point. Simultaneously press the L and R buttons for about 2 seconds to set to 0.

4) **B ADJUST** : Sets blue gamma point.

Setting range is from -128 to 127. Press R to raise and L to lower blue video signal gamma point. Simultaneously press the L and R buttons for about 2 seconds to set to 0.

5) **Initialize** : Returns level menu settings to preset values. Simultaneously press L and R for about 2 seconds.

6) **File select** : Selects scene files 1 - 4 and preset.

## 12. DTL

Menu for setting detail parameters

**1) DTL FREQUENCY** : DTL amplifying frequency changeover.

- **LOW** : The lower band frequency is amplified.
- **MID** : The standard amplification is performed.
- **HIGH** : The high band frequency is amplified. Finer contour correction is carried out.

**2) Hi chroma DTL** : High chroma detail on/off

At on setting, contours are enhanced in highly colored components of the scene.

**3) Color DTL** : Selects color detail mode

- **CH1, CH2** : Color detail is effective at the either selection. Sets the detail level of two color phase ranges. Select each color phase setting with CH1 and CH2.
- **Off** : Color detail is ineffective.

**4) Auto setup** : Color detail phase is detected automatically. Set the marker to the desired color area and press R for automatic detection (indicates OK when completed).

**5) Level** : Sets color detail level

Range is -128 (soft) to 127 (sharp). Press both L and R for about 2 seconds to set to 0.

**6) Phase** : Sets color detail phase

Present phase is indicated beside the setting values. Since the VBS output is shown as monochrome on the monitor, a monochrome indication can also be used for an approximate setting. At Auto setup, the automatically detected phase setting is indicated.

**Note:** At RGB or R-Y, B-Y output, the detected phase range is not shown on the monitor. Use a VBS signal for color detail setting.

**7) Width** : Sets color phase range for setting

Setting range is -128 (narrow) to 127 (wide). Since the VBS output is shown as monochrome on the monitor, a monochrome indication can also be used for an approximate setting. Press both L and R for about 2 seconds to set to 0.

**Note** : At RGB or R-Y, B-Y output, the detected phase range is not shown on the monitor. Use a VBS signal for color detail setting.

**8) Initialize** : Returns level menu settings to preset values. Simultaneously press L and R for about 2 seconds.

**9) File select** : Selects scene files 1 - 4 and preset.

**10) DTL SUB** : Change to DTL SUB menu.

### 13. DTL SUB

#### 1) **LEVEL DEP** : Dependent level setting

Detail amount, and noise, can be reduced in scene dark components.

Setting range is -128 to +127. Press the R button to increase the value, reduce the detail amount and expand the video signal level range. Press L button to decrease the value and reduce the range. Set to 0 by simultaneously pressing the L and R buttons for about 2 seconds.

#### 2) **CRISP** : Crispness level setting

Reduces noise when DTL setting is in the range of -128 to 127. However, at high settings, some loss of sharpness occurs in detailed scene components. Press the R button to increase the value and the detail noise. Press the L button to decrease the value and reduce detail noise. Set to 0 by simultaneously pressing the L and R buttons for about 2 seconds.

#### 3) **H/V BALANCE** : Balance setting for horizontal and vertical detail amount

Setting range is -128 to +127. Press the R button to increase the value and reduce the H DTL amount. Press the L button to decrease the value and reduce the V DTL amount. Set to 0 by simultaneously pressing the L and R buttons for about 2 seconds.

#### 4) **Initialize** : Returns DTL SUB menu settings to preset values. Simultaneously press L and R for about 2 seconds.

## 14. Ext trigger

The external trigger function is used with a frame grabber to obtain an image of an object at a desired exposure time. Settings can provide images at various timings. The exposure time can be controlled by the external trigger pulse width.

### 1) **Trigger mode** : Selects external trigger mode

- Mode 1: Use for exposure time less than 2 fields.
- Mode 2: Use for exposure time greater than 2 fields.

**Note:** Longer integration time tends to show increased noise and flaws in the CCD.

### 2) **Delay time** : Time from end of trigger pulse to camera sync reset

Setting range is 3 to 20 H. Can be used with a strobe light source to provide an optimum image with a frame grabber.

### 3) **Trig polarity** : Selects positive or negative trigger pulse polarity.

### 4) **WE polarity** : Selects WE pulse polarity

Selects pulse (WE) output synchronized to image obtained from the camera rear panel multi connector for 1 field or 1 frame. Use to match the interface of an external frame grabber or other equipment.

The trigger and CCD mode timing can be combined to obtain image timing as indicated in the figures.

**a) MODE: MODE1, CCD MODE: FLD**

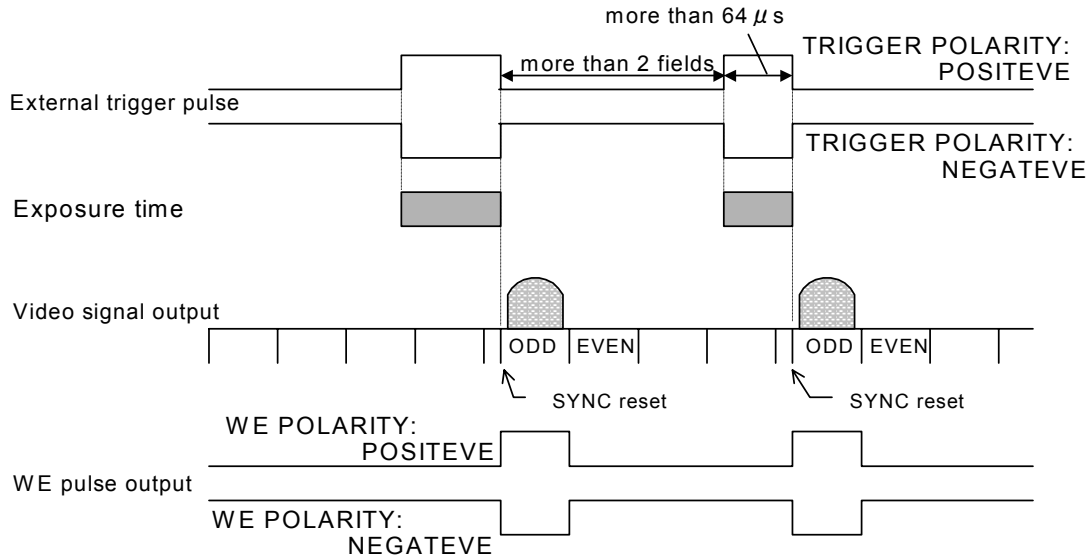

**b) MODE: MODE1, CCD MODE: FRM**

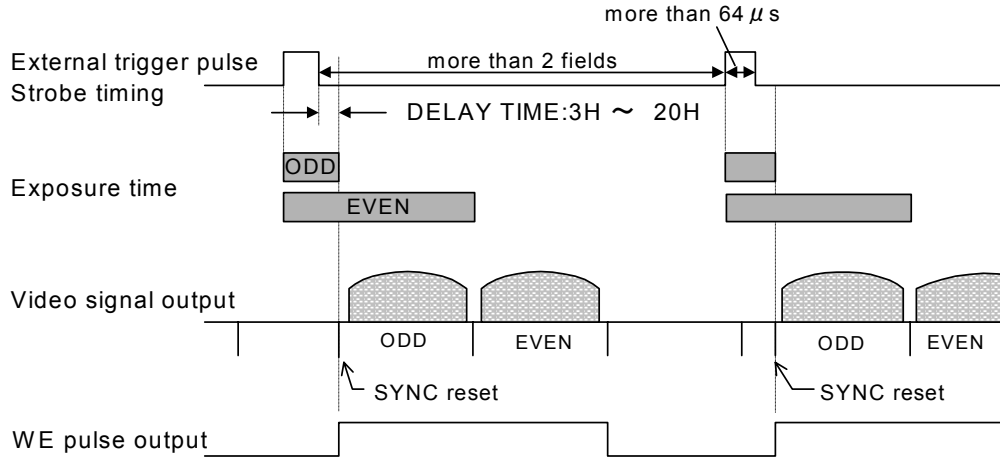

**Note:** When the flashlight is not used, the even and odd video signal levels are difference.

**c) MODE: MODE2, CCD MODE: FLD**

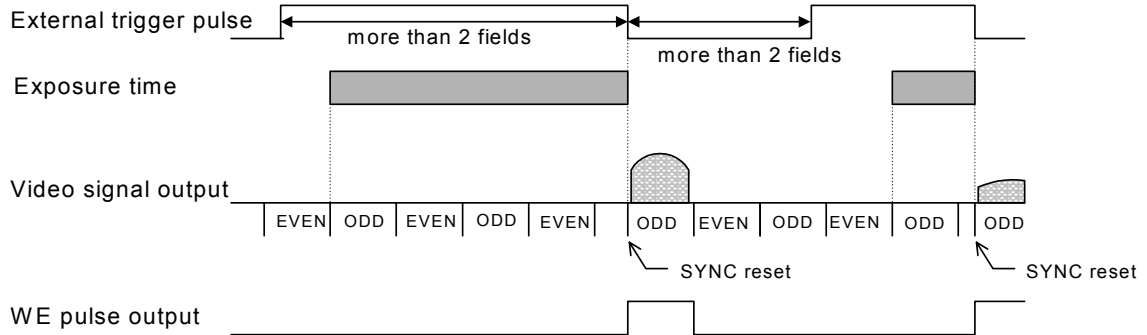

**d) MODE: MODE2. CCD MODE: FRM**

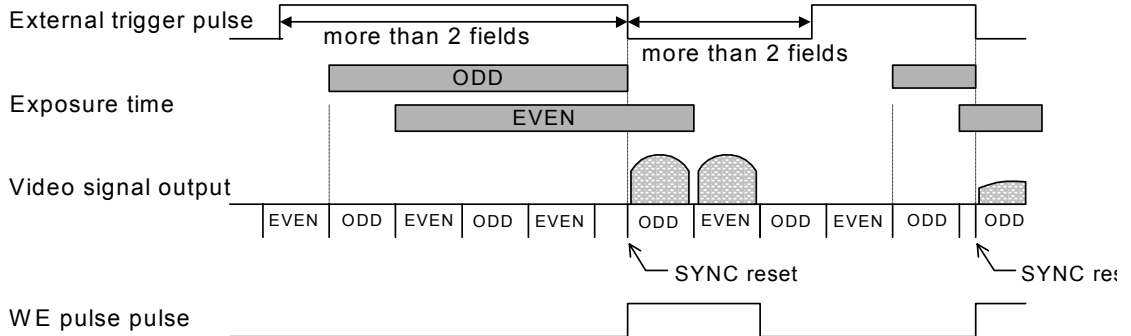



## Note: Prohibited period of the external trigger pulse timing

For each external trigger mode, when the end edge of external trigger pulse is input in the prohibited period (shown in the under figure), the picture is not output after the SYNC reset.

Please input the repetition period of trigger pulse with the following specification, to avoid the trigger input to an above prohibited period.

The period of the next end edge trigger pulse from the previous end edge of trigger

CCD MODE: FLD, except from  $nV$  to  $nV+2H$

CCD MODE: FRM, except from  $2nV$  to  $2nV+2H$

( $V$ : a vertical synchronous period,  $n$ : an integer)

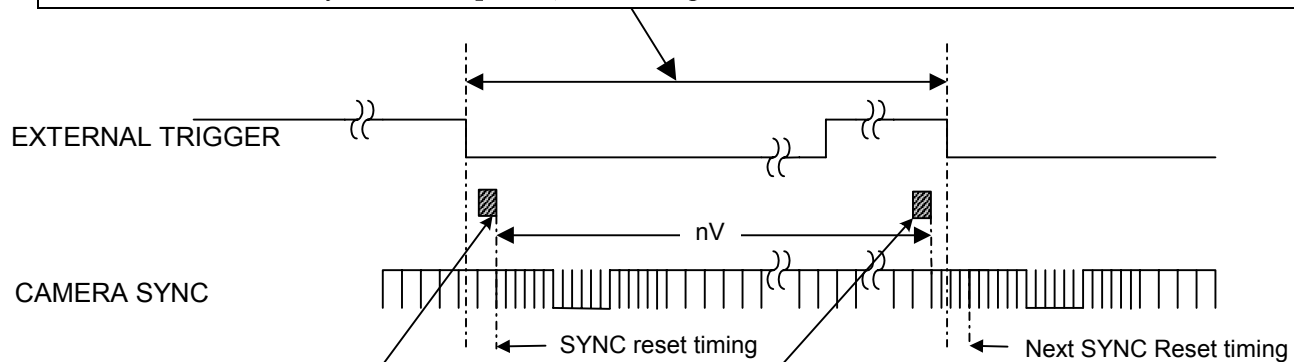

Prohibited period of the end edge of external trigger pulse  
(1H period before the start of camera V SYNC)

## 15. OUTPUT/SYNC

On this menu screen, you can make signal changeover for output to the D-SUB connector and phase adjustment for external synchronization.

### 1) **OUTPUT** : Output mode changeover

- R, G, B : The R, G and B video signals are output to the D-SUB connector.
- Y, R-Y, B-Y : The Y, R-Y and B-Y signals are output to the D-SUB connector.
- Y/C : The Y/C and VBS signal is output to the D-SUB connector.

### 2) **COLOR BAR** : Color bars ON/OFF

### 3) **MONO** : Monochrome (black and white) ON/OFF for the video output signal from the VIDEO connector Set to ON for monochrome. Setting ineffective during color bar.

### 4) **Sync/HD out** : Selects sync signal output from the rear panel multi connector.

### 5) **SYNC ON G** : G video signal synchronization ON/OFF (In the R/G/B mode only) When output is RGB with Sync on and G on, Sync is added to the G video signal.

### 6) **GL IN** : Impedance changeover of input to the GL IN connector.

- HIGH : The high impedance level is provided.
- 75Ω : An impedance of 75 ohms is provided.

**Note:** When power to the camera is turned off, the high impedance level is provided. So, do not use this function in a system where power is turned off for the camera unit only.

**7) GL MODE** : GL signal input changeover

- VBS : The VBS signal or BBS (black burst) signal is input as an external synchronizing signal.
- HD/VD : The HD/VD signal is input as an external synchronizing signal.

**Note:** During external sync with HD and VD signals, be sure to use either RGB or Y, B-Y, R-Y output signals. Although VBS and Y/C output signals are also produced, these cannot be used as normal output signals.

**8) SC.COARSE** : Coarse adjustment of subcarrier phase

Using the L or R button, select one of the following phases; 0°, 90°, 180° and 270°.

**9) SC.FINE** : Fine adjustment of subcarrier phase

The allowable setting range is -128 to 127.

There is no direct relationship between a numeric value and a degree of phase. If the relevant range is exceeded, the SC COARSE setting is updated automatically to permit continuous adjustment.

**10) H.PHASE** : Adjustment of horizontal synchronization phase

The allowable setting range is -128 to 127.

## 16. File set

Use for transferring scene file data to another file or setting all data to preset values.

- 1) **FILE SELECT** : Selects scene file 1 - 4 or preset for copy data.
- 2) **STORE FILE** : Selects file for storing scene file data.
- 3) **STORE** : Press L and R for more than 1 second to transfer selected scene file data to store file.
- 4) **STORE PRESET** : Press L and R for more than 1 second, the selected scene file is stored in the preset file.
- 5) **ALL INITIALIZE** : Press L and R for more than 1 second, to initialize all scene file data to preset values.

## 17. OTHER FUNC

### 1) **NEGA** : NEGA image ON/OFF

At the ON setting, the output video becomes negative image.

### 2) **FLARE** : Flare compensation on/off

Corrects for extraneous reflections in the optical and CCD systems which end to weaken bright image components. Normally set to on.

### 3) **FLARE LEVEL**: Setting range is -128 (smaller) to 127 (larger compensation).

### 4) **KNEE POINT** : Use L and R to set in the range -128 (smaller) to 127 (larger). Normally set to where gradation appears above 100% video level.

### 5) **WHITE CLIP** : Sets white clip level

Use L and R to set in the range of -128 (lower) to 127 (higher) clip level. Normally set for clip at about 110% video level. Adjust when there is excess video level from the equipment interface.

### 6) **MESSAGE RTN** : Message display ON/OFF

- **ON** : A message indicating the result of AWB/ABB execution in the DIRECT mode is displayed.
- **OFF** : A message indicating the result of AWB/ABB execution in the DIRECT mode is not displayed.

### 7) **REMOTE** : Set remote control baud rate

Use R and L to set for 2400, 4800, 9600 or 19200 bps. Set to 9600 bps when using the optional RC-Z3 remote control box.

**8) REMOTE TYPE** : Selects between modes 1 and 2.

- **MODE 1**: Select to use the same computer commands as other camera models (e.g., HV-C20 series).
- **MODE 2**: Normal setting. Use for the RC-Z3 remote control box.

**9) ID/TITLE** : Change to ID/TITLE menu

**10) Pixel correct** : White flaw compensation on/off

Normally set to on. When image processing equipment is used, since the data of 1 pixel are not precise, the off setting might provide better results in such cases.

## 18. ID/TITLE

ID and title display position and data setting menu.

### 1) ID : ID display position setting

Once an ID is assigned, it becomes possible to control a particular camera unit remotely from a personal computer according to its ID. That is, multiple camera units can be remote-controlled individually from one personal computer.

At this function item, specify whether the ID is displayed on screen or not. In case that the ID is displayed on screen, specify its display position also.

- OFF : Not displayed.
- TOP : Displayed at the upper right corner of screen.
- BOTTOM : Displayed at the lower right corner of screen.

### 2) At this function item, specify whether the TITLE is displayed on screen or not. In case that the TITLE is displayed on screen, specify its display position also.

- OFF : Not displayed.
- TOP : Displayed at the upper left corner of screen.
- BOTTOM : Displayed at the lower left corner of screen.

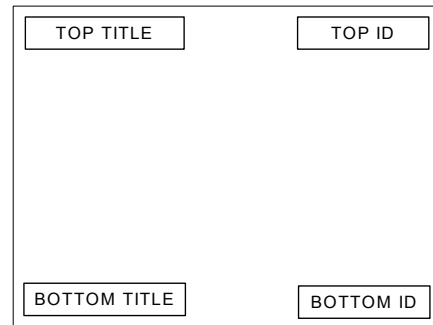

ID/TITLE Display Position

**3) DATA SET** : The DATA SET screen comes up.

ID : Enter an ID code consisting of three characters.

Alphanumeric upper-case characters and a space character are permitted.

TITLE : Enter a TITLE consisting of up to 12 characters.

Alphanumeric upper-case characters, special symbols and a space character are permitted.

**Note:** The symbol "  " in the data represents a space character. On the actual screen, a space character is given as a blank in an ID code or TITLE.

**<ID/TITLE Setup Procedure>**

- i) With the cursor located at DATA SET, press the D button. The cursor moves to the ID data set position and the first character flashes.
- ii) Using the L, R, U and D buttons, select an input character.
- iii) Press the SET UP button, and the selected character will be entered. (The cursor will then move to the next character position.)
- iv) In the same manner, repeat the above steps ii) and iii) to enter an ID code and TITLE.
- v) On completion of character input, bring the cursor to RET using the L, R, U or D button. Then, press the SET UP button.  
The cursor is returned to DATA SET.
- vi) To quit the SPECIAL SET mode, press the SET UP button.

<- : Flashing shifts one character toward the left.

-> : Flashing shifts one character toward the right.

DEL : Flashing character is deleted, and the subsequent character string is shifted left.

INS : A space is inserted at the flashing character position, and the subsequent character string is shifted right.

RET : The cursor is returned to DATA SET.

# How to Attain Better Images

## Black Balance Adjustment

Adjust black balance to provide proper color tone at a dark part of video image. In the following cases, be sure to carry out black balance adjustment.

- When using the camera first after purchasing it.
- When using the camera after it has been unused for a long time.
- When the camera operating environment is changed (e.g., when the ambient temperature varies significantly).

Under normal condition, it is not required to make black balance adjustment at power-on.

1. In the menu mode, carry out automatic black balance adjustment. At the end of successful adjustment AUTO BLACK:OK appears.

- Notes:**
- 1) Where the lens having the auto iris function is used, the iris is closed automatically during adjustment.
  - 2) In combinational use with the manual iris lens or microscope, a full-black screen image is provided from the CCD image sensor during adjustment. When picturing after adjustment, a white screen image appears momentarily. This phenomenon is not a symptom of trouble, however.
  - 3) In case that the manual iris lens is used, do not attempt auto black balance adjustment while taking an image of subject having extremely high luminance such as the sun. This may deteriorate black balance accuracy.

2. If black balance adjustment cannot be made, any one of the following messages will appear. Take a proper procedure according to the error message, and then try black balance adjustment again.

Error message	Procedure
AUTO BLACK : BAR	<ul style="list-style-type: none"> <li>• Turn off the color bar.</li> </ul>
AUTO BLACK : NG	<ul style="list-style-type: none"> <li>• Close the lens iris.</li> <li>• Avoid taking an image of subject having high luminance such as the sun, or decrease illumination on the microscope.</li> <li>• Carry out AUTO BLACK again. If this message appears in repeated attempts, it is necessary to inspect the inside of the camera. In this case, notify your local Hitachi Denshi sales agent or Hitachi Denshi service office</li> </ul>

### White Balance Adjustment

Carry out white balance adjustment when the illumination condition (color temperature) is changed.

Adjust the white balance when using the camera for the first time or after replacing the lens.

1. In the MENU mode, set up WHITE BAL: MEM.
2. Turn off the MENU screen to select the DIRECT mode.
3. Provide a proper aperture value of lens using the auto iris function or manually.
4. Put a white object in the subject image, and zoom it up.
5. Hold the AWB button pressed for about 2 seconds for automatic white balance adjustment. With MESSAGE RTN:ON, AUTO WHITE appears. At the end of successful adjustment AUTO WHITE:OK appears.
6. If white balance adjustment cannot be made, any of the following messages will appear. Take a proper procedure according to the error message, and then try white balance adjustment again.

Error message	Procedure
AUTO WHITE : NG CHANGE TO CAM TRY AGAIN	<ul style="list-style-type: none"> <li>• Turn off the color bar.</li> </ul>
AUTO WHITE : NG CHANGE TO MEMORY MODE TRY AGAIN	<ul style="list-style-type: none"> <li>• Set up WHITE BAL:MEM.</li> </ul>
AUTO WHITE : NG LOW LIGHT TRY AGAIN	<ul style="list-style-type: none"> <li>• White balance cannot be made due to insufficient illumination.</li> <li>• Increase the intensity of illumination, turn lens iris toward open direction, or increase the gain to provide a proper video level.</li> <li>• Press the AWB switch again.</li> </ul>
AUTO WHITE : NG HIGH LIGHT TRY AGAIN	<ul style="list-style-type: none"> <li>• White balance cannot be made due to excess illumination.</li> <li>• Increase the intensity of illumination, turn lens iris toward closed direction, or increase the gain to provide a proper video level.</li> <li>• Press the AWB switch again.</li> </ul>
AUTO WHITE : NG C.TEMP HIGH TRY AGAIN	<ul style="list-style-type: none"> <li>• The color temperature is too high, making it impossible to reach the optimum value in adjustment. (If there is no problem in practical application, use the camera under the current condition.)</li> <li>• Add a filter to the lens or illumination to decrease the color temperature.</li> </ul>
AUTO WHITE : NG C.TEMP LOW TRY AGAIN	<ul style="list-style-type: none"> <li>• The color temperature is too low, making it impossible to reach the optimum value. (If there is no problem in practical application, use the camera under the current condition.)</li> <li>• Add a filter to the lens or illumination to increase the color temperature.</li> </ul>
AUTO WHITE : NG LONG SHUTTER MODE CHANGE SHUTTER MODE TRY AGAIN	<ul style="list-style-type: none"> <li>• Release the long shutter mode.</li> </ul>
CAM MODE : AUTO CHANGE TO MANUAL	<ul style="list-style-type: none"> <li>• Set camera mode to manual.</li> </ul>

## Realtime Auto White

The camera detects a white part in the image by itself, and its internal microcomputer automatically adjusts white balance in real time. Use this function in case that the color temperature varies with time (e.g., from morning to day to night).

1. In the MENU mode, set up WHITE BAL: AUTO.

Where the camera is mounted fixedly and the orientation and image-taking range of the camera remain unchanged. It is advisable to use the white gate function in combination for attaining higher accuracy in white balance.

1. In the MENU mode, set up WHITE GATE: ON.
2. Using the WHITE GATE menu in the MENU mode, bring the display window to a monochrome part (white or gray part) in the image.

For details of the WHITE GATE function, refer to page 27. Be sure to set the WHITE GATE window to a white or gray part in the image. Do not set it to a colored part.

## Auto Shading Correction

Color shading may occur in the vertical direction on screen due to any characteristic of lens. This camera is equipped with a function for correcting color shading automatically.

1. Provide a proper aperture value of lens using the auto iris function or manually.
2. Take a white image fully on screen. At this step, take care so that uneven brightness will not occur in the vertical direction.
3. In the DIRECT mode, press the AWB button. White balance is adjusted automatically.

- 
4. In the DIRECT mode, while holding down U button and D button for more than two seconds and press the D button or in the MENU mode, carry out AUTO SHADING. Thus, color shading in the image is corrected automatically.

- Notes**
- 1) When using the camera for the first time or after replacing the lens, just be sure above instructions.
  - 2) If adjusted under a light source that has a flicker component, such as fluorescent or mercury, the white balance accuracy can be impaired. Change the electronic shutter mode (Sub-menu 1 Shutter or Variable) setting to reduce flicker before engaging the auto white balance adjustment.

## **ALC**

In combination of GAIN:AGC, SHUTTER:AES and AUTO IRIS, the following four kinds of ALC (auto level control) can be performed. This feature ensures stable video signal output according to a wide-range change in illumination.

**Note :**

1. AES cannot be combined with a Video type lens.
2. When not using an auto iris lens, at the Lens menu, set Lens Type to DC and Iris Mode to Manual.

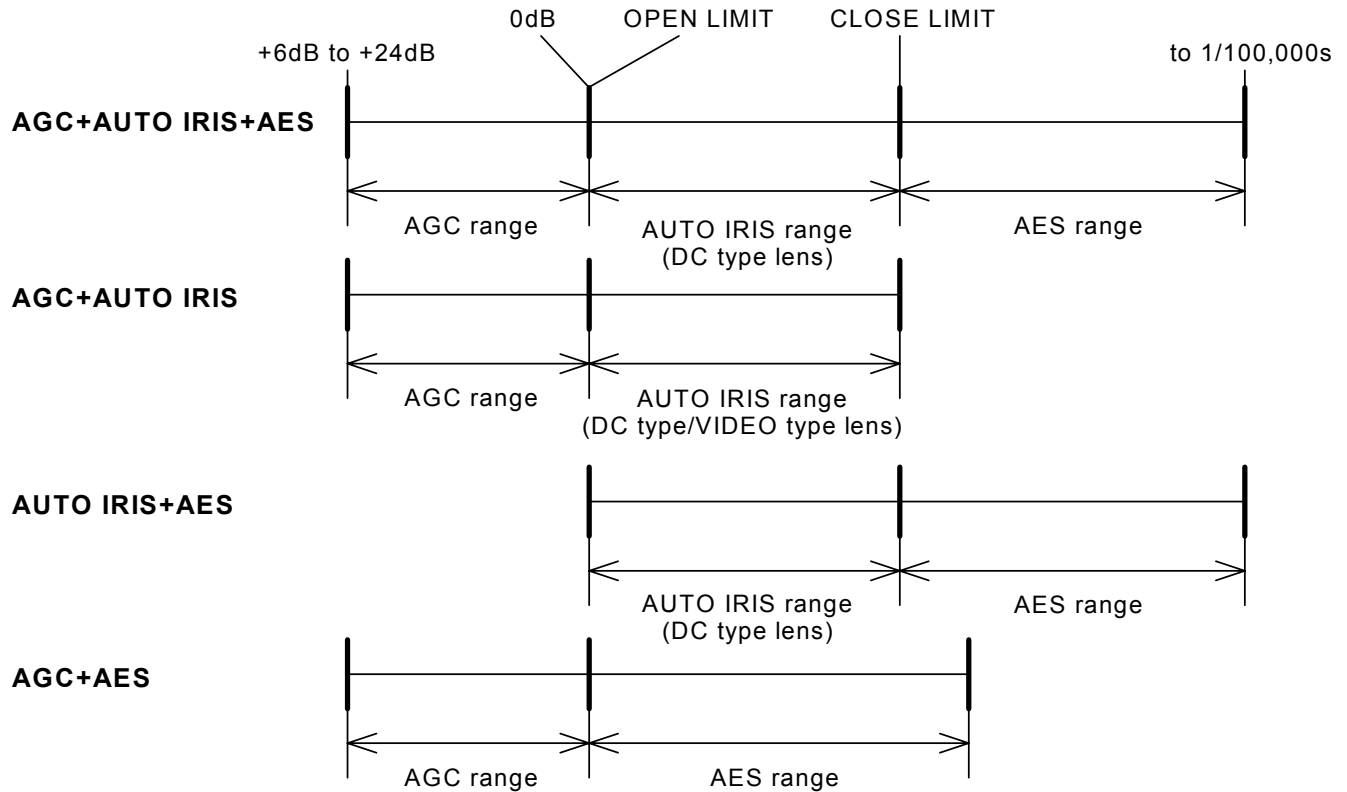





Frame store mode

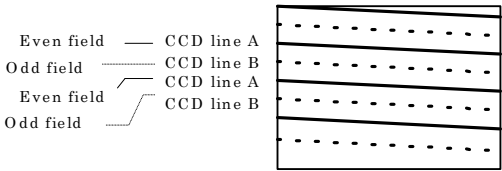

In the frame store mode, each of the CCD lines A and B is read out individually. Therefore, the vertical resolution is superior. After completion storing, video signal output is made between two fields. Immediately before the field on which video signal output is made, the WE signal is delivered from the D-SUB connector equipped on the rear panel.

Store time: 1/15 s (Example)

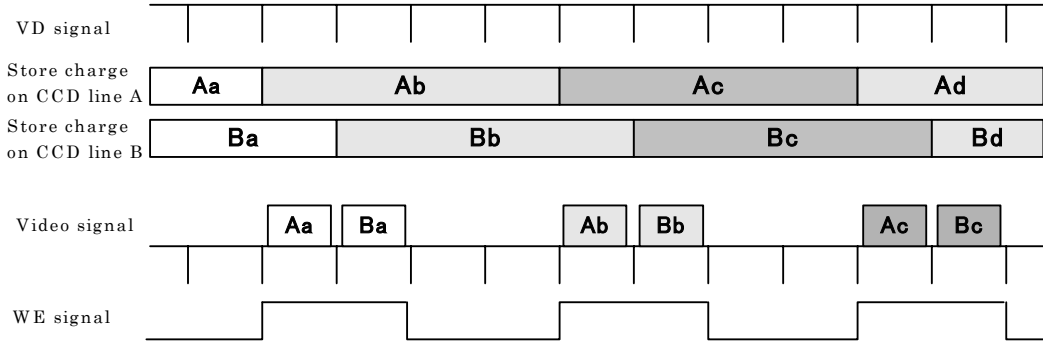

# RC-Z3 Remote Control Panel

All camera menu items can be operated remotely by connecting the RC-Z3 Remote Control Panel. Connect the panel as follows.

- (1) Set camera internal switch SW806 to RC-Z3.  
See internal switch selection on page 63.
- (2) Open the SPECIAL SET menu and set the camera communications rate to 9600 bps.(see page 42).

## Operation

### (1) Direct control

The following items can be controlled directly as well as from the control panel.

- BAR/CAM
- WHITE BAL
- GAIN
- DTL
- IRIS MODE
- SHUTTE(ON/OFF)
- CONTRST(ON/OFF)
- ENABLE(ON/OFF)
- R GAIN
- B GAIN
- R BLK
- B BLK
- IRIS
- M.BLK
- A.WHT
- A.BLK
- SCENTE FILE

### (2) MENU controls

All control items are set from menu. Press the FUNCTION button of the remote control panel to produce the menu mode and display the MAIN MENU screen. Again press the FUNCTION button to extinguish the menu screen and return to the direct mode.

Operate the menu with the UP, DOWN, LEFT and RIGHT buttons.

**Note:** While pressing the UP button presses the FUNCTION button for 2 seconds to produce the special set mode. The SPECIAL SET menu appears.



### (3) Setting data store

Setting data (menu and direct control items) are not automatically stored when using the RC-Z3. Press the RC-Z3 STORE button and the SCENE FILE button of the location for storing the data.

**Note:** Use care since the data are lost if the application is changed or the power cut off without storing.

# 1. RC-Z3 panel facilities

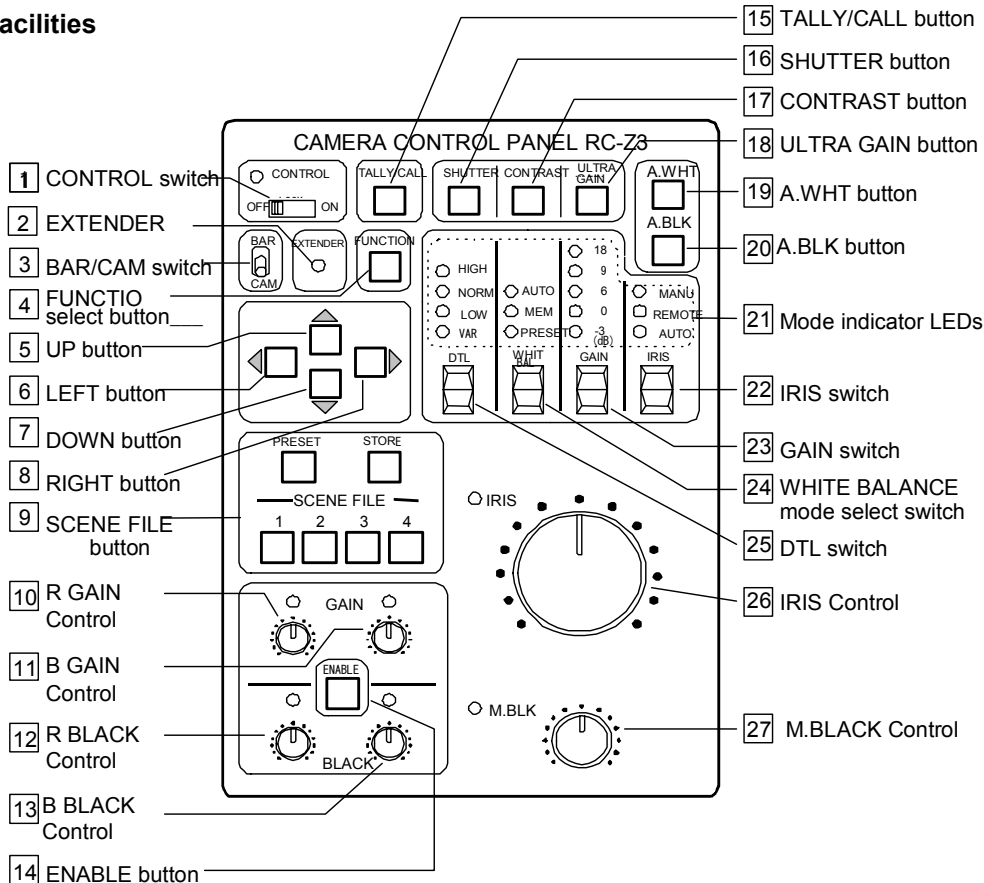



**1 CONTROL switch**

- ON (red LED) : Normal camera control from.
- LOCK (red LED): All controls and switch RC-Z3 has locked at present settings, except IRIS **26** and M. BLK **27**. Prevents accidental or unauthorized operation.
- OFF (green LED): Operation inhibited from RC-Z3. Operate from camera controls and switches.

**2 EXTENDER LED**

This Extender LED is always extinguished using with the HV-D20 camera.

**3 BAR/CAM switch**

Selects the camera output signal.

- BAR: Color bar signal output
- CAM: Camera video signal output

**4 FUNCTION select button**

Camera setting menu display button.

**5 UP, 6 LEFT, 7 DOWN and 8 RIGHT buttons**

Menu screen operating buttons.

**9 SCENE FILE buttons**

Select camera application files and stores scene file data. Four application files can be used as scene files.

**Scene files:**

To shoot several scenes with different shooting conditions, it is needed to change settings suitable for each scene. To reduce such troublesome operations, various shooting conditions can be memorized previously to scene files, and the conditions most suitable for a scene can be read and set. The RC-Z3 is provided with four files, and four different shooting conditions can be memorized.

## (1) File selection

Press the following buttons to change the camera and RC-Z3 settings.

- **PRESET:** Produces the standard setting mode
- **SCENE FILE 1:** FILE-1 (scene file 1) setting mode
- **SCENE FILE 2:** FILE-2 setting mode
- **SCENE FILE 3:** FILE-3 setting mode
- **SCENE FILE 4:** FILE-4 setting mode

**Note:** The pressed SCENE FILE button lights, then flashes when the application file data are changed. Flashing continues if the data are changed or the original value is returned. When again pressed, the button lights steadily.

## (2) Setting data store

The Store function is used to save the application file item data. The common file item data are saved during adjustment and operation.

- **Store operation**

After entering the settings with the menu screen and RC-Z3, press the STORE button (the STORE button flashes). Then press the desired SCENE FILE button for storing the settings (STORE button extinguishes).
- **Store release**

While the STORE button is flashing, again press the button. The STORE button extinguishes and the mode is released.
- **File data copy**

Press the Preset or SCENE FILE button of the source, then press the STORE button (flashes). Next press the SCENE FILE button of the destination file. The settings are copied and stored in the designated file.

### Store operation notes:

1. After adjustment and operation with the RC-Z3, neglecting the Store operation before pressing a file button loses the adjustment and setting item data. The output is the designated file data prior to adjustment and operation.
2. After adjustment and operation with the RC-Z3, neglecting the Store operation before cutting off the power loses the adjustment and setting item data. The output is the designated file data prior to adjustment and operation.

Be sure to conduct the Store operation when desiring to save the data after adjustment and operation.

In this case, the data prior to Store are deleted.

### 10 R GAIN and 11 B GAIN control

Red and blue video signal gain can be adjusted. Press the EN<sup>14</sup>LE button (lights) to allow adjusting.

Adjustment is coarse when the WHITE BALANCE mode select switch <sup>24</sup> is set to Preset and fine when set to Memory.

### 12 R BLACK and 13 B BLACK control

Red and blue video signal black level can be adjusted. Press the ENABLE <sup>14</sup> button (lights) to allow adjusting.

**Note:** When CAM MODE AUTO, R & B black cannot be adjusted.

### 14 ENABLE button

- ON : Button lights to indicate R & B gain and R & B black adjustments are effective.
- OFF: Adjustments are ineffective when the ENABLE button is extinguished.

**Note:** When CAM MODE AUTO, the ENABLE button is ineffective.



- 15 TALLY/CALL button**  
TALLY/CALL button lights when pressed. However, function is ineffective in the HV-D30 camera.
- 16 SHUTTER button**  
Shutter on/off; lights when on.  
Note: When CAM MODE AUTO, the Shutter button is ineffective.
- 17 CONTRAST button**  
Contrast on/off; lights when on.  
Note: Inoperative with gamma off (gamma set to off at SUB MENU 2 of menu mode).
- 18 ULTRA GAIN button**  
Ultra gain on/off. However, function is ineffective in the HV-D20 camera.
- 19 A.WHT button**  
Direct mode: At White balance mode MEM, press A.WHT to conduct automatic white balance (button lights). The resulting data are stored in application file memory.  
Menu mode : A.WHT button operation is inhibited.
- 20 A.BLK button**  
Direct mode: Press A.BLK to conduct automatic black balance (button lights).
- 21 Mode indicator LEDs**  
Indicate status of switches below LEDs.

## 22 IRIS switch

Sets lens iris mode.

Press the switch upward to set the mode in the sequence AUTO→REMOTE→MANUAL.

- AUTO : Automatic iris operation
- REMOTE: Iris is adjusted by the iris control **26**
- MANUAL: Set the lens A/M switch to M and adjust the lens iris ring manually.

**Note:** When using the video type lens, REMOTE and MANUAL function is ineffective in the HV-D30 camera.

## 23 GAIN switch

Sets the camera sensitivity. Press the switch upward to select the sensitivity in the sequence 0→3→6→9→12→15→18→21→24 dB. The sensitivity setting is indicated by the combined GAIN LED indication.

**Note:** When CAM MODE AUTO or AGC ON, the -3dB GAIN LED indicated all the time.

## 24 WHITE BALANCE mode select switch

The white balance mode can be selected in the sequence PRESET → MEM →AUTO.

- PRESET: Optimum white balance at 3200 K and 5600 K color temperature. Select between 3200 K and 5600 K in the menu mode at W. PRST MODE of the MAIN MENU screen.
- MEM : Press the A.WHT button **19** for automatic white balance adjustment. Select between 3200 K and 5600 K in the menu mode at W. MEM MODE of the MAIN MENU screen.
- AUTO : White balance is automatically adjusted in real time (ATW)

When the RC-Z3 white balance mode is set to MEM and AUTO, at the MAIN MENU, W. MEM MODE is indicated and at PRESET, W.PRST MODE is indicated.

**Note:** When CAM MODE AUTO, camera white balance is automatic.  
Selection from the RC-Z3 select switch is ineffective.

## 25 DTL switch

Camera detail setting.

Press the switch to select in the sequence VARIABLE→LOW→NORMAL→HIGH. During VAR, the mode indicator LEDs show the detail amount; in the menu mode, the MAIN MENU screen DTL setting is OFF or VAR.

## 26 IRIS control

Adjusts the lens iris as follows.

- AUTO : OVER-RIDE (fine adjustment about  $\pm 2$  F-stops) can be adjusted
- REMOTE: Adjustable in the range from fully open to fully closed
- MANUAL: Iris is not adjustable from the RC-Z3 (adjust by manually turning the lens iris ring).

## 27 M. BLK control

Adjusts the master black level

## 2. Menu screen composition

Camera settings other than the RC-Z3 items can be customized using the main and special set menus. The menu structure is same as one of camera.

# Function Selection by Internal Switch Setting

## 1. SW806

For connection with the remote control box RC-Z3, set SW806 to the RC-Z3 position.

For connection with the personal computer, set SW806 to the RS-232C position.

At shipment from factory, SW806 is set at the RS-232C position.

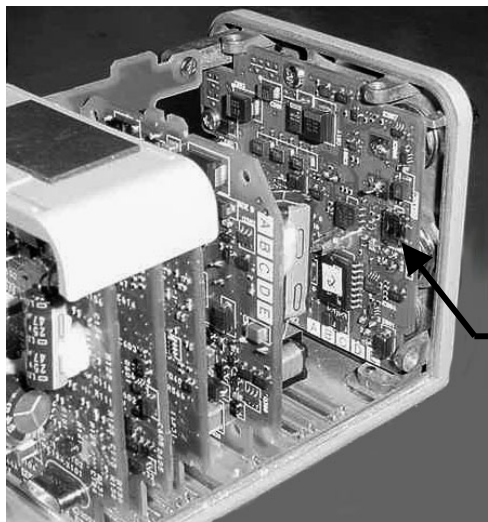

RS-232C

SW806

RC-Z3

## 2. SW401

For selection SYNC or HD/VD output and GL or HD/VD input of multi connector.

At shipment from factory, SW401 is set at the OUT position.

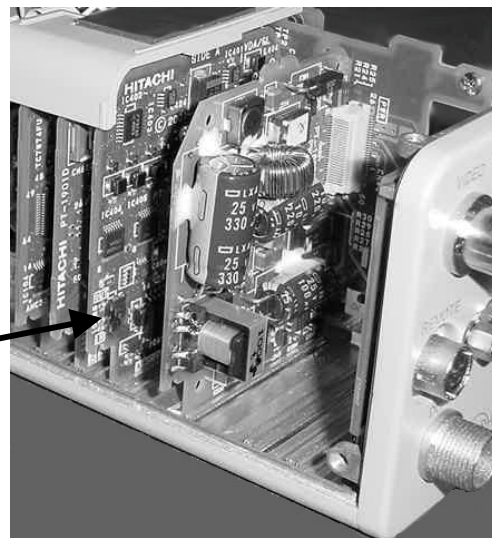

OUT

SW401

IN

# Connectors

## MULTI connector (DMSH-15S)

Pin No.	Signal designation
1	R/R-Y/C OUT
2	G/Y/Y OUT
3	B/B-Y/VBS
4	WE OUT
5	GND
6	VIDEO GND
7	VIDEO GND
8	VIDEO GND
9	UNREG +12V IN
10	TRIG IN
11	GND
12	RXD
13	HD IN/HD OUT/ SYNC OUT
14	VD IN/GL IN /VD OUT
15	TXD

PLAG : Housing KEC-15P  
 Pin contact JK-SP2140  
 Cover JK-C151C

\* Use No.4-40UNC plug retaining screws.

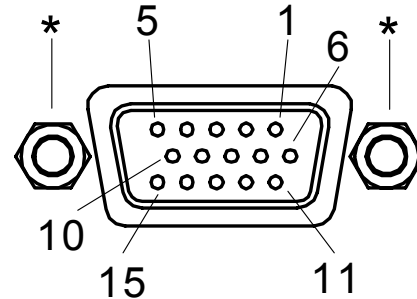

### REMOTE connector (HR10A-7R-4S)

Pin No.	Signal designation
1	+12V output
2	RXD/SD input
3	TXD/SD output
4	GND

Plug: HR10A-7P-4P

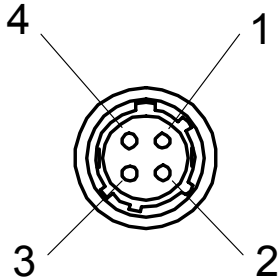

### LENS connector (D4-151N-100)

Pin No.	Signal designation
1	+12V
2	NC
3	Control
4	GND

Plug: E4-191J-100

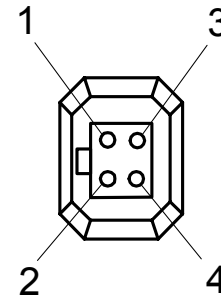

### DC IN connector (R03-R3M2)

Pin No.	Signal designation
A	GND
B	+12V input
C	NC

Plug:R03-P3F

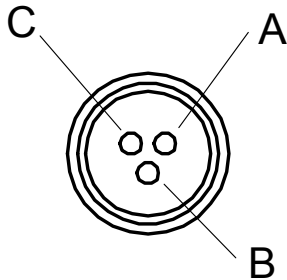

## Specifications

- |                          |   |
|--------------------------|---|
| 1) Color system          | PAL   |
| 2) Optical system        | 1/2-inch, F1.6 prism  |
| 3) Imaging system        | R, G, B 3 CCD   |
| 4) Picture elements      | Corresponding to 1/2-inch interline transfer CCD<br>(with microlenses)  |
| Total pixels             | 795 (H) × 596 (V)   |
| Effective pixels         | 752 (H) × 582 (V)   |
| Effective image area     | 6.35 (H) × 4.78(V) mm   |
| 5) Scanning system       | 2:1 interlace   |
| 6) Scanning frequency    | 15.634 kHz (H) × 50.00 Hz (V)   |
| 7) Encoder system        | R-Y/B-Y   |
| 8) Sync system           | Internal/external<br>(VBS, BBS or HD/VD auto selection, when<br>internal input/output switch is input position) |
| 9) Horizontal resolution | 800 TV lines, luminance signal center<br>(Y out and DTL off)  |
| 10) S/N                  | 62 dB type (DNR on), 59 dB type (DNR off)<br>(Y out, $\gamma=1$ , DTL off, GAIN 0 dB)                           |
| 11) Standard sensitivity | 2000 lx, F11  |
| 12) Minimum illumination | 0.4 lx<br>(50 IRE, F2.2, GAIN +24 dB, DIGITAL GAIN +12 dB)  |
| 13) Gamma correction     | 0.45/1.0 (on/off)   |
| 14) Geometric distortion | Full screen 0% (not including lens characteristics)   |
| 15) Registration         | Full screen 0.05% (not including lens characteristics)  |

- |     |                               |  |
|-----|-------------------------------|--|
| 16) | Vertical contour compensation | 2H   |
| 17) | Lens mount                    | C mount (flangeback 17.25 mm in air)   |
| 18) | Sensitivity selection         | AGC (0 to +24 dB)<br>or GAIN (0 to +24 dB step 1dB or step 3 dB on<br>remote control menu)   |
| 19) | Detail control                | DTL level and frequency  |
| 20) | Scene files                   | 4 Files  |
| 21) | Digital gain                  | +6 dB, +12 dB sensitivity increase by digital signal processing  |
| 22) | CCD drive functions           |  |
|     | Preset:                       | 1/60, 1/250, 1/500, 1/1000, 1/2000, 1/4000,<br>1/10,000 1/20,000 1/40,000 1/100,000second  |
|     | Lockscan:                     | 1/50.31 to 1/2024 second (step 1H)<br>to 1/100,000 second (step approx. 10% video level)   |
|     | AES:                          | Off to approx. 1/100,000 second  |
|     | Long term integration:        | Field/frame integration selectable<br>1/25 to approx. 8 seconds (1 frame steps)<br>(external image memory needed for continuous image) |
|     | Frame readout                 | improves vertical resolution<br>(residual image response deterioration)  |
| 23) | Color bar                     | Full   |
| 24) | Power supply voltage          | 12 V rated<br>(Stable operation at 10.5 to 15 VDC (ripple and noise absent))   |
| 25) | Power consumption             | Approx. 5 W  |



- |                         |                                    |
|-------------------------|------------------------------------|
| 26) Dimensions          | 65 (W) × 65 (H) × 130 (D) mm       |
| 27) Mass                | Approx. 400 g (not including lens) |
| 28) Ambient temperature | Operating -10 to 45 °C             |
|                         | Storage -20 to 60 °C               |

# Input/Output Signals

## 1. Input signal conditions

1) Genlock input (MULTI connector)

- VBS 1.0 V<sub>p-p</sub> ±3 dB or black burst/75 ohm or high (BNC)  
(sync 0.3 ±0.1 V<sub>p-p</sub>, burst 0.3 ±0.1 V<sub>p-p</sub>)
- HD/VD 2 to 5 V<sub>p-p</sub>, negative (D-sub connector)

**Note:** Genlock input and Sync output are selected by internal input/output switch.

2) External trigger input (MULTI connector)

Ext Trig Low 0 VDC, High 2 to 5 VDC

3) Serial data (REMOTE connector)

1.5 V<sub>p-p</sub> ±3 dB/High (when connected to RC-Z3, JU-C20, JU-Z2)  
RS-232C level (when connected to personal computer)

**Note:** Set internal switches according to connected equipment.

A level converter JU-C20 is required if controlling the camera from a personal computer via RS-232C interface over a distance more than approx.15 meter.

## 2. Output signal ratings

1) Component video output (VIDEO, MULTI connector)

VBS 1.0 V<sub>p-p</sub>/75 ohm

2) Y/C output (MULTI connector)

Y: 1.0 V<sub>p-p</sub>/75 ohm

C: NTSC 0.286 V<sub>p-p</sub> (burst)/75 ohm

PAL 0.3 V<sub>p-p</sub> (burst)/75 ohm

3) Component output (MULTI connector)

Y : 1.0 Vp-p/75 ohm

R-Y: 0.7 Vp-p/75 ohm

B-Y: 0.7 Vp-p/75 ohm

4) RGB output (MULTI connector)

R: 0.7 Vp-p/75 ohm

G: 0.7 Vp-p/75 ohm

B: 0.7 Vp-p/75 ohm

**Note:** YC/VBS, component and RGB MULTI connector outputs are selected by menu.

5) Sync outputs (MULTI connector)

HD: 2 Vp-p/75 ohm

VD: 2 Vp-p/75ohm

Sync: 2 Vp-p/75ohm

**Note:** Genlock input and Sync output are selected by internal input/output switch.

6) Serial data output (REMOTE connector)

1.5 Vp-p/Low (when connected to RC-Z3, JU-C2-, JU-Z2)

RS-232C level (when connected to personal computer)

**Note:** Set internal switches according to connected equipment.)

7) Lens iris control output (Lens connector, manual override)

IRIS CONT : 1.5 V (closed) to 5.5 V (open) or 2.5 V (closed) to 7.5 V (open)

Selectable

# Major accessories

Camera control box, RC-Z3

Camera Junction box, JU-Z2

RS-232C level converter JU-C20

# Dimensions

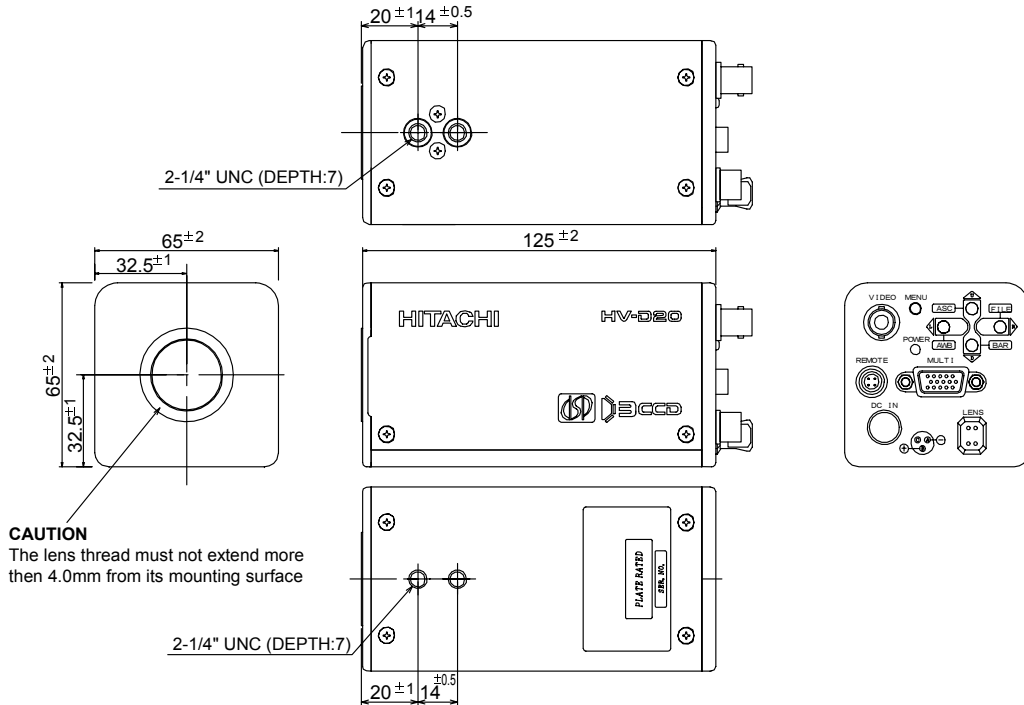

# Hitachi Kokusai Electric Inc.

Head Office 14-20, Higashi-Nakano 3-chrome, Nakano-ku, Tokyo 164-8511, Japan  
Phone : +81 (0) 3-3365-5928, Fax : +81 (0) 3-3365 5929  
URL : [www.h-kokusai.com](http://www.h-kokusai.com)

## **Hitachi Denshi (Europa) GmbH**

Head office Weiskircher Straße 88, D-63110 Rodgau, Germany  
Phone : +49 6106-69920, Fax : +49 6106-16906  
URL : [www.hitachi-denshi.de](http://www.hitachi-denshi.de)  
General email address : [webmaster@hitachi-denshi.de](mailto:webmaster@hitachi-denshi.de)

## **Hitachi Denshi (Europe)**

Leeds Office Brookfield House, Selby Road, Garforth, LEEDS, LS25 1NB, United Kingdom  
Phone : +44 (0)113 287 4400, Fax : +44 (0)113 287 4260  
URL : [www.hitachi-denshi-uk.com](http://www.hitachi-denshi-uk.com)  
General email address : [sales@hitachi-denshi-uk.com](mailto:sales@hitachi-denshi-uk.com)

## **Hitachi Denshi (UK) Limited**

Head office Windsor House, Britannia Road, Waltham Cross, Hertfordshire, EN8 7NX, United Kingdom  
Phone : +44 (0) 1992 704 595, Fax : +44 (0) 1992 704 599